

# Gasket Packing

Other Sealing Products

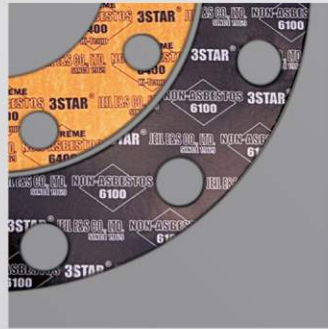

- Non-Asbestos Sheets & Gaskets
- Semi Metallic Gaskets
- Metal Gaskets
- Insulation Textiles
- Gland Packings
- Rubber Sheets & Gaskets
- Insulation Set

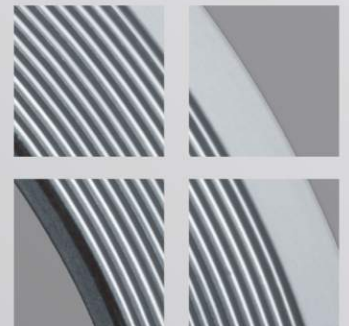
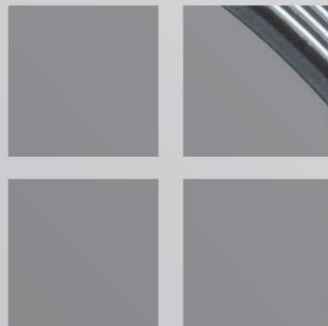

# Value Creation for Customers!

**A giant leap for future and environment beyond 40 years of tradition!**

**Do better tomorrow with excellent human resources and state-of-the-art-technologies.**

**It's Creative Technology! JEIL E&S**



## SEALING BUSINESS DIVISION

JEIL E&S has been a leading company in the gasket, packing, fluoroplastics fields of business since it founded as Jeil Chemical Industry Co. in 1969. JEIL E&S has contributed for the national economic development. JEIL E&S established new plant in Qingdao China to expand production capacity and joint venture plants in Indonesia and Malaysia to mark as a global leading company beyond its reputation as a 1st manufacturer of sealing products in Korea.

JEIL E&S SEALING BUSINESS DIVISION has production capacity of more than 5 million spiral wound gaskets for a year! Producing 5,000 tons of compressed jointing sheets for a year! Calendaring machines which manufactures the standard compressed jointing sheets have diverse sizes from 48 to 108 inch wide state-of-the-art equipments to produce competitive products with tremendous R&D and facility investment. Especially the cryogenic spiral wound gaskets which apply to LNG vessel approved by DNV(Det Norske Veritas), Lloyd's and Korean Register of Shipping prove that our products and technology are the best quality among companies in the same line of business.

Based on the experience and know-how accumulate in the field of sealing products during the last four decades, we remain one step ahead to meet the needs of global customers with advanced and creative quality products. The belief that a happy person can make good products, that is our business philosophy to pursue the creative technology!



## Mission & Business Strategy

**World Best Leader for Total Sealing & Integrated Engineering Products with Customer Satisfaction and Top Quality**

Innovative Production

Innovative Technology

Innovative Mind

Innovative Operation

Talent Upbringing

**In time Worldwide Service from Overseas Manufacturing System (China, Indonesia, Malaysia, Singapore, etc.)**







## STARFLON BUSINESS DIVISION

JEIL E&S STARFLON business division commits the customized manufacturing system to meet the needs of customers in advance with competitive technology supplying cost-effective products! With the progress of national semiconductor industry in 1990, STARFLON business division has expanding it's solid business to extend factory in Hwasung securing systematic manufacturing lines and to meet the diverse expectations of customers from the standard types to various types requiring no fluid contamination.

Especially the PTFE products are highly applied to diverse areas such as semiconductor chemical tanks, medicine, steel mill and chemical industries.

JEIL E&S Advanced technology of quality has proven through the R&D and obtained a patent for inventing the electrolytic polishing drum which demands high application for all sorts of chemical vessels.

Beyond customer satisfaction, fulfilling quality management to move the hearts of customers!



## ENGINEERING BUSINESS DIVISION

Based on the experience and know-how accumulated meanwhile, JEIL E&S ENGINEERING BUSINESS division carries out the turn key base process covering from design to construction! JEIL E&S jumps up to be a specialized engineering company for Fluoroplastics such as PTFE & PFA lined tanks and relevant processing in the business of special resins with our rich experience and advanced technology.

We've been in partnership with national leading engineering companies to provide products and facilities in the cutting edge new material industry areas including semiconductors, LCD, steel mill, petrochemical and poly silicon. Based on the overseas construction projects experience in China and Indonesia, we explored the Middle East with national major construction companies to meet the expectations and needs of our needs of our customers providing high quality of services with advanced competitive technology and continuous innovation coupled with creative ideas.



# Contents



07

## Non-Metallic Sheets & Gaskets

### Compressed Non-Asbestos Sheets & Gaskets

#### A. Industrial Applications

Aramid Fiber + NBR	JIC 6000	08
Aramid Fiber + NBR + Wire Reinforced	JIC 6000W	09
Aramid Fiber + NBR	JIC 6010	10
Organic Fiber + NBR	JIC 6030	11
Aramid Fiber + SBR	JIC 6100	12
Aramid Fiber + NBR	JIC 6200	13
Carbon Fiber + NBR	JIC 6400	14
Carbon Fiber + NBR + Wire Reinforced	JIC 6400W	15

#### B. Automotive Applications

Aramid Fiber + Synthetic Rubber	JIC 6210	16
Aramid Fiber + NBR	JIC 6215	
Aramid Fiber + Synthetic Rubber	JIC 6330	17
Aramid Fiber + NBR	JIC 6700	

### STARFOIL® Sheets & Gaskets

STARFOIL® (Flexible Graphite) Sheets & Gaskets	JIC 4201Series	18
Pure Graphite Sheet	JIC 4201	
Stainless Steel Flat Reinforced Graphite Sheet	JIC 4201-P	
Stainless Steel Tanged Reinforced Graphite Sheet	JIC 4201-B	
Stainless Steel Wire-Mesh Reinforced Graphite Sheet	JIC 4201-W	
STARFOIL® Plain Tape	JIC 4204	19
STARFOIL® Crinkled Tape	JIC 4205	

### STARFLON® Sheets & Gaskets

STARFLON® (PTFE) Solid Gasket	JIC 8305	20
STARFLON® (PTFE) Reinforced Gasket	JIC 8305G	
STARFLON® (PTFE) Enveloped Gasket	JIC 8310	21
STARFLON® (PTFE) Jacketed Gasket	JIC 8313	
STARFLON® (PTFE) Expanded Sheet Gasket	JIC 8312	22
STARFLON® (PTFE) Joint Sealant Gasket	JIC 6066	

### STARPITE® Sheets & Gaskets

Stainless Steel Reinforced STARPITE® Sheet (For High Temperature)	JIC 4201-HT	24
--	-------------	----

#### Description

Properties for Compressed Non-Asbestos Sheet Materials	25
How to handle and use compressed Non-Asbestos Gaskets	26

• STARFOIL®, STARFLON®, STARPITE® & STARTEC™ are registered Trademark of JEIL E&S.



27

## Semi-Metallic Gaskets

### Spiral Wound Gaskets

STARFOIL® (Flexible Graphite) Filled Type	JIC 38□□-SF Series	28
Non-Asbestos Filled Type	JIC 38□□-NA Series	
STARFLON® (PTFE) Filled Type	JIC 38□□-TF Series	29

### High Temperature Spiral Wound Gaskets

Multi-Filler Filled Type	JIC 380□-Multi-Filler	30
	JIC 380□-R-Multi-Filler	
	JIC 383□-Multi-Filler	
	JIC 383□-R-Multi-Filler	
STARPITE® Filled Type	JIC 380□-HT	31
	JIC 380□-R-HT	
Multi-Filler Filled Type(HTG)	JIC 383□-HT	
	JIC 383□-R-HT	
	JIC 380□-HTG	
	JIC 380□-R-HTG	
	JIC 383□-HTG	
	JIC 383□-R-HTG	

### Metal Jacketed Gaskets

Non-Asbestos Filled (NA) Filler	JIC 38□□-NA Series	32
Ceramic (CE) Filler	JIC 38□□-CE Series	
STARFOIL® (SF) Filler	JIC 38□□-SF Series	33
STARFOIL® Tape Attached	JIC 38□□-SF(SF) Series	

### Kammprofile Gaskets

Parallel Root	JIC 3850-SE(SF)	35
Floating Centering Ring	JIC 3850-SEB(SF)	
Convex Root	JIC 3850-SEC(SF)	

#### Description

Spiral Wound Gasket Description	36
Application for Flanges(Spiral Wound Gasket)	
Maximum Bore of ASME B 16.5 Flanges for use with Spiral Wound Gaskets	
Standard Type Metal Jacketed Gaskets	
Standard Shapes for Heat Exchanger Gaskets	



43

## Metal Gaskets

### Ring Joint Gaskets

Oval Type	JIC 3850-V	43
Octagonal Type	JIC 3850-C	
BX Type	JIC 3850-BX	
RX Type	JIC 3850-RX	



## Other Metal Gaskets

Plain Type	JIC 3850-P	44
Lens Ring Type	JIC 3850-L	
Double Cone Type	JIC 3850-DC	
Bridgeman Type	JIC 3850-B	
Delta Type	JIC 3850-D	
Serrated Type	JIC 3850-SE	
Weld Ring Type Series	JIC 3850-WR	
Corrugated Type	JIC 3850-COR	
Metal O-Ring	JIC 3800	

### Description

Metal Gaskets Information (Material & Type etc.)	45
--	----



46

## Insulation Textiles

Glass Fiber Cloth	JIC 7000	46
Glass Fiber Tape	JIC 7200	
Ceramic Fiber Cloth	JIC 7300	
Ceramic Fiber Tape	JIC 7400	
Silica Fiber Cloth	JIC 7500	
Silica Fiber Tape	JIC 7600	



47

## Gland Packing

Expanded Graphite Packing	JIC 3020	47
Inconel Wire Inserted Expanded Graphite Packing	JIC 3020-I	
PTFE Fiber Packing	JIC 3063	48
Lubricated PTFE Fiber Packing	JIC 3064	
Lubricated PTFE Fiber and Aramid Fiber Packing	JIC 3065	
Lubricated PTFE Fiber and Graphite Fiber Packing	JIC 3067	
PTFE / Graphite Fiber Packing	JIC 3076	49
PTFE Fiber Packing	JIC 3076-W	
Hatch Cover Packing	JIC 3069	
	JIC 3069-GS	
Inconel Wire Inserted Carbon Fiber Packing	JIC 3072	50
PTFE Impregnated Carbon Fiber Packing	JIC 3074	
Lubricated Carbon Fiber Packing	JIC 3074-CR	
Lubricated PTFE Impregnated Carbon Fiber Packing	JIC 3075	
PTFE Impregnated Carbonized Fiber Packing	JIC 3094	51
Lubricated PTFE Impregnated Carbonized Fiber Packing	JIC 3095	
PTFE / Graphite Fiber and Aramid Fiber Packing	JIC 3077	
Lubricated PTFE Impregnated Aramid Fiber Packing	JIC 3080	
Inconel Wire Inserted Glass Fiber Packing	JIC 3085	52
STARFOIL® Molded Packing	JIC 4101	
Anti - VOC Packing Set	JIC 4101-VOC	

### Description

pH Values	53
Properties	



54

## Rubber Sheets & Gaskets

Natural Rubber Sheets & Gaskets (NR Rubber)	JIC 9000(9001)-NR
Nitrile Butadiene Rubber Sheets & Gaskets (NBR Rubber)	JIC 9000(9001)-NBR
Chloroprene Rubber Sheets & Gaskets (Neoprene Rubber)	JIC 9000(9001)-CR
EPDM Rubber Sheets & Gaskets	JIC 9000(9001)-EPDM
Silicon Rubber Sheets & Gaskets	JIC 9000(9001)-SL
Styrene Butadiene Rubber Sheets & Gaskets (SBR Rubber)	JIC 9000(9001)-SBR
Fluoro Elastomer Sheets & Gaskets (VITON Rubber)	JIC 9000(9001)-FKM
Isobutylene-Isoprene Rubber Sheets & Gaskets (Butyl Rubber)	JIC 9000(9001)-IIR
STARFLON® / EPDM Rubber Gaskets	JIC 9010-EPDM

### Description

Products Description	55
Properties & Chemical Resistance	



56

## Insulation Sets

RF Type	JIC 7700-R	56
FF Type	JIC 7700-F	
RTJ Type	JIC 7700-RJ	

STARFLON® (PTFE) Solid Gasket	JIC 8305	57
STARFLON® (PTFE) Reinforced Gasket	JIC 8305G	
CR Rubber Faced Phenolic Gasket	JIC 9020-CP	

### STARTEC™ Gasket

Glass Reinforced Epoxy Plate Gasket With Rubber Seal	JIC 9210-ER
Glass Reinforced Phenolic Plate Gasket With Rubber Seal	JIC 9220-PR
Glass Reinforced Epoxy Plate Gasket With Rubber O-Ring	JIC 9230-ES
Epoxy Faced Metal Plate with Rubber O-Ring	JIC 9310-OS
Epoxy Faced Metal Plate with PTFE Seal	JIC 9320-OS

### STARPITE® Kammprofile Gasket

Parallel Root & Integral Centering Ring Type	JIC 3850-SE(HT)
Floating Centering Ring Type	JIC 3850-SEB(HT)
Convex Root Type	JIC 3850-SEC(HT)

## Appendix

Gasket Installation Procedure	58
Gasket Recommend Assembly Stress & Torque Values	
Gasket Standard Dimension Table	
Non-Metallic Gaskets Dimension	
Spiral Wound Gaskets Dimension	
Ring Joint Gaskets Dimension	
Kammprofile Gaskets Dimension	
Gasket Chemical Resistance Chart	
Gasket Materials and Contact Facings	

# Certificates & Patents

## Korean Standards Association



**ISO 9001**  
Quality Management System  
KS Q ISO 9001:2009  
/ ISO 9001:2008



**ISO 14001**  
Environmental Management System  
KS I ISO 14001:2009  
/ ISO 14001:2004



**ISO 18001**

## Det Norske Veritas (DNV)



**Cryogenic Service for LNG Plants & Carriers**  
Spiral Wound Gasket

## Korean Resister (KR)



**Type Approval**  
Non-Asbestos Joint Sheet

## Lloyd's Register



**Type Approval**  
Non-Asbestos Joint Sheet



**Type Approval**  
Non-Asbestos Joint Sheet

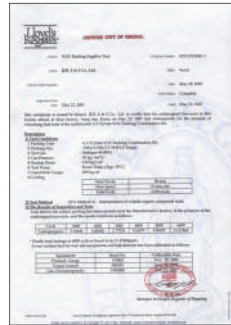

**Fugitive Test**  
VOC Packing

## Yarmouth Research and Technology, LLC

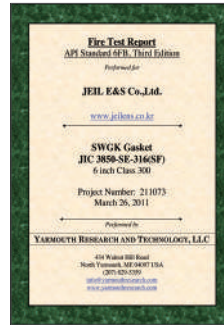

**API 6FB Fire Test**  
Metal Gaskets

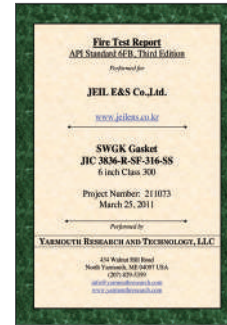

**API 6FB Fire Test**  
Spiral Wound Gaskets

## Fire Insurers Laboratories of Korea



**Fire Endurance Test**  
Non-Asbestos Joint Sheet

## Achilles JQS



**Joint Qualification System**

## Aramco Overseas Company



**Vendor Registration**

## Patents

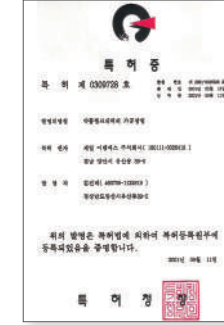

제 0309728 호

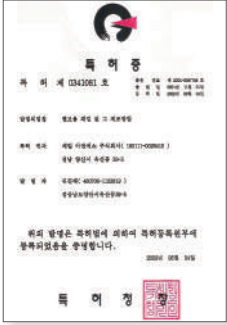

제 0341081 호

## Kuwait National Petroleum Company



**Vendor Registration**

## KHNP (Korea Hydro & Nuclear Power Co., LTD)

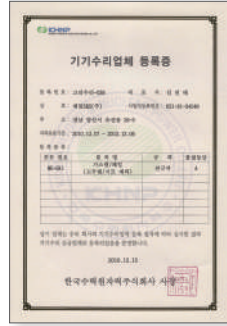

**Vendor Registration**

## API Monogram



**API 6A**  
API 6A : 2010 / ISO 10423 : 2009  
Metallic Gasket

## Patents

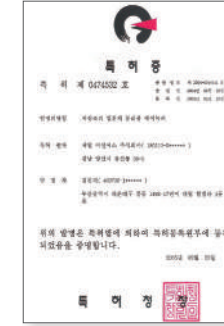

제 0474532 호

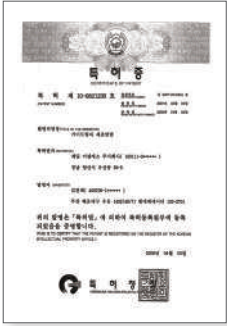

제 10-0821230 호



# Non-Metallic Sheets & Gaskets

Compressed Non-Asbestos Sheets & Gaskets

STARFOIL® Sheets & Gaskets

STARFLON® Sheets & Gaskets

STARPITE® Sheets & Gaskets

STARFOIL®, STARFLON®, STARPITE® & STARTEC™ are registered Trademark of JEIL E&S

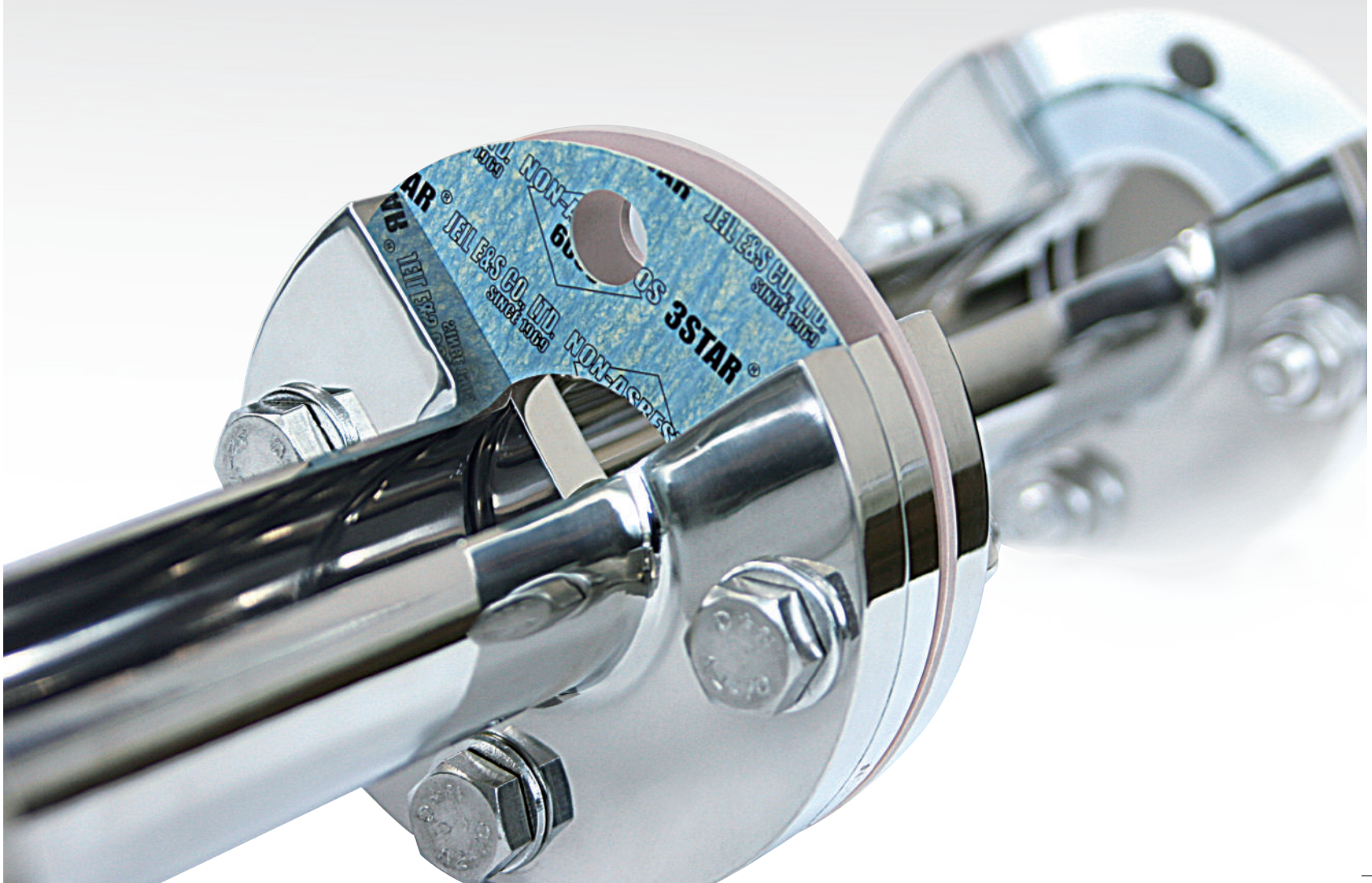

## Non-Metallic Sheets & Gaskets

### Compressed Non-Asbestos Sheets & Gaskets

## Aramid Fiber + NBR

### JIC 6000

#### Industrial Applications

##### [Characteristic]

JIC-6000 is manufactured by the hot calender process using high quality Non-Asbestos fiber (Aramid Fiber) and oil resistant synthetic rubber (NBR). Specially, this sheet has superior sealing performance with excellent oil resistance.

내열성이 우수한 고품질의 보강섬유(Aramid Fiber)와 내유성 고무(NBR)를 사용하여 특히 기름에 안정적이며 우수한 밀봉성을 발휘하는 범용시트.

##### [Application]

Short-term peak Temp.	350°C [ 662°F ]
Maximum continuous Temp.	220°C [ 428°F ]
Short-term peak Pressure	80kgf/cm <sup>2</sup> [ 7.85 MPa ]

Applied Fluids : Water, Alkali, Salt Solution, Hot Oil, Oil Gas, Freon Gas below, Organic Solvent

##### [Service Range]

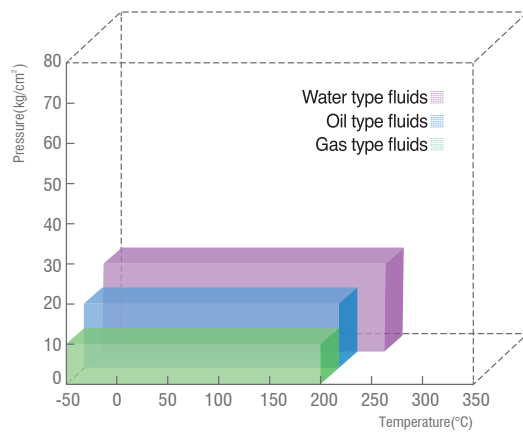

\* Maximum Temp. & Pressure combinations can not be used at the same time.

##### [Size]

Thickness(mm)	0.5 ~ 3.2
Sheet(mm)	1270×1270 / 1270×2540
	1270×3810 / 1520×1520
	2540×3810 / 1520×3040

\* Other Sizes can be available, if required.

\* One or both sides Graphite & PTFE coating available, if required.



##### [Typical Physical Properties]

Test Method	Description	JIC 6000
	Density [ g/cm <sup>3</sup> ]	1.7
ASTM F152	Tensile strength Across grain.MPa (kgf/mm <sup>2</sup> )	13.7 (1.4)
ASTM F36J	Compressibility [ % ]	9
	Recovery [ % ]	55
ASTM F146	Fluid Resistance after 5hrs immersions	
	ASTM #3 oil (150°C) Thickness Increase [ % ]	5
	Tensile Loss [ % ]	23
ASTM Fuel B (20~30°C)	Thickness Increase [ % ]	5
	Weight Increase [ % ]	9
	ASTM F147	Flexibility
ASTM F495	Ignition Loss [ % ] 850°C(1123°F) x 30min	29

\* All data are typical values

##### [Design Data]

Thickness(mm)	Gasket Factor(m)	Min. Design Seating Stress (y) kgf/cm <sup>2</sup> (psi)
3.2	2.00	112 (1600)
1.6	2.75	260 (3700)
0.8	3.50	457 (6500)

##### Note

Water type fluids : For steam line, spiral wound gasket or graphite sheet gasket is recommended.

Oil type fluids : For organic solvents, use below 150°C

Gas type fluids : Do not use for toxic & explosive gas line

\* If properties out of guideline needed, Please contact our Technical Team.



## Non-Metallic Sheets & Gaskets

### Compressed Non-Asbestos Sheets & Gaskets

## Aramid Fiber + NBR + Wire Reinforced

### JIC 6000W

#### Industrial Applications

##### [Characteristic]

This 6000W is an excellent quality Non-Asbestos gasket material (same compounds of JIC-6000) with stainless steel wire-mesh inserted to be suitable for exhaust Line under high temperature and high pressure (Aramid Fiber + NBR Binder).

내열성이 우수한 고품질의 보강섬유(Aramid Fiber)와 기름에 안정적인 NBR고무를 사용했으며, 시트 내부에 스테인레스 금망을 넣어 보강한 시트로서 고온, 고압에 우수한 성능을 발휘하고 Exhaust Line에 적합한 제품.

##### [Application]

<b>Short-term peak Temp.</b>	400°C [ 752°F ]
<b>Short-term peak Pressure</b>	100kgf/cm <sup>2</sup> [ 9.8 MPa ]
<b>Applied Fluids :</b> Suitable for Water, Hot Oil, Oil Gas Alkali, Salt Solutions, Solvents, Etc. Not be Used in Steam, Strong Acid and Alkali, Soluble Chemicals.	

##### [Service Range]

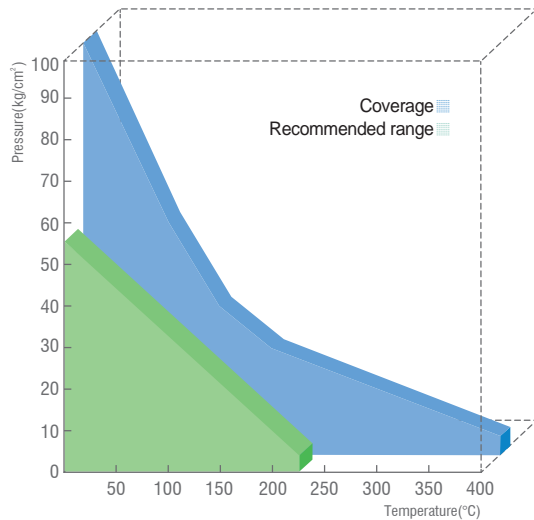

\*Maximum Temp. & Pressure combinations can not be used at the same time.

##### [Size]

<b>Thickness(mm)</b>	1.0 ~ 3.2
<b>Sheet(mm)</b>	1524×3100

\*Other Sizes can be available, if required.

\*One or both sides Graphite & PTFE coating available, if required.



##### [Typical Physical Properties]

Test Method	Description	JIC 6000W
	Density [ g/cm <sup>3</sup> ]	1.7
ASTM F152	Tensile strength Across grain.MPa (kgf/mm <sup>2</sup> )	17.7 (1.8)
ASTM F36J	Compressibility [ % ]	9
	Recovery [ % ]	53
ASTM F146	Fluid Resistance after 5hrs immersions	
	ASTM #3 oil (150°C) Thickness Increase [ % ]	5
	Tensile Loss [ % ]	21
ASTM F147	ASTM Fuel B (20~30°C) Thickness Increase [ % ]	3
	Weight Increase [ % ]	11
	Flexibility	No Crack
ASTM F495	Ignition Loss [ % ]	25
	850°C(1123°F) x 30min	

\*All data are typical values

##### [Design Data]

Thickness(mm)	Gasket Factor(m)	Min. Design Seating Stress (y) kgf/cm <sup>2</sup> (psi)
3.2	2.00	112 (1600)
1.6	2.75	260 (3700)
0.8	3.50	457 (6500)

##### Note

Water type fluids : For steam line, spiral wound gasket or graphite sheet gasket is recommended.

Oil type fluids : For organic solvents, use below 150°C

Gas type fluids : Do not use for toxic & explosive gas line

\*If properties out of guideline needed, Please contact our Technical Team.

## Non-Metallic Sheets & Gaskets

### Compressed Non-Asbestos Sheets & Gaskets

## Aramid Fiber + NBR

### JIC 6010

#### Industrial Applications

##### [Characteristic]

High quality heat resistant fiber (Aramid Fiber) and excellent oil resistant synthetic rubber (NBR) are compounded and calendered into a gasket sheet for oil resistance required applications.

내열성이 우수한 고품질의 보강섬유(Aramid Fiber)와 내유성 고무(NBR)를 사용하여 양호한 내유성이 요구되는 곳에 적합한 시트.

##### [Application]

Short-term peak Temp.	260°C [ 500°F ]
Maximum continuous Temp.	180°C [ 356°F ]
Short-term peak Pressure	60kgf/cm <sup>2</sup> [ 5.88 MPa ]

Applied Fluids : Water, Hot Water, Oils, Mild acids and alkalis.

##### [Service Range]

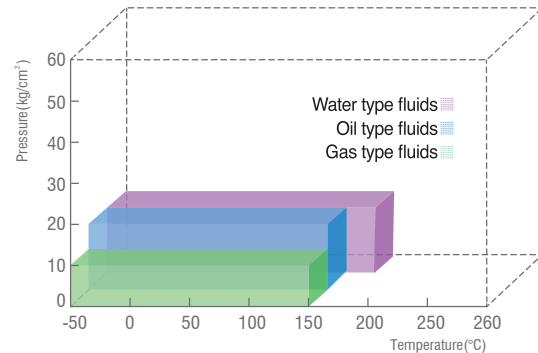

\*Maximum Temp. & Pressure combinations can not be used at the same time.

##### [Size]

Thickness(mm)	0.5 ~ 3.2
Sheet(mm)	1270×1270 / 1270×2540
	1270×3810 / 1520×1520
	2540×3810 / 1520×3040

\*Other Sizes can be available, if required.

\*One or both sides Graphite & PTFE coating available, if required.

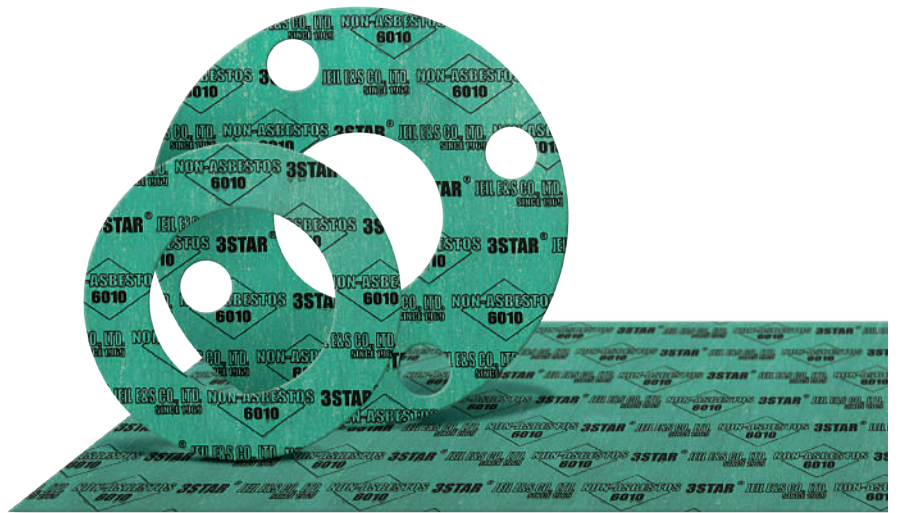

##### [Typical Physical Properties]

Test Method	Description	JIC 6010
	Density [ g/cm <sup>3</sup> ]	1.6
ASTM F152	Tensile strength Across grain.MPa (kgf/mm <sup>2</sup> )	10.8 (1.1)
ASTM F36J	Compressibility [ % ]	11
	Recovery [ % ]	53
ASTM F146	Fluid Resistance after 5hrs immersions	
	ASTM #3 oil (150°C) Thickness Increase [ % ]	6
	Tensile Loss [ % ]	26
ASTM F147	ASTM Fuel B (20~30°C) Thickness Increase [ % ]	5
	Weight Increase [ % ]	13
	Flexibility	No Crack
ASTM F495	Ignition Loss [ % ]	31
	850°C(1123°F) x 30min	

\*All data are typical values

##### [Design Data]

Thickness(mm)	Gasket Factor(m)	Min. Design Seating Stress (y) kgf/cm <sup>2</sup> (psi)
3.2	2.00	112 (1600)
1.6	2.75	260 (3700)
0.8	3.50	457 (6500)

##### Note

Water type fluids : For steam line, spiral wound gasket or graphite sheet gasket is recommended.

Oil type fluids : For organic solvents, use below 150°C

Gas type fluids : Do not use for toxic & explosive gas line

\*If properties out of guideline needed, Please contact our Technical Team.



## Non-Metallic Sheets & Gaskets

### Compressed Non-Asbestos Sheets & Gaskets

## Organic Fiber + NBR

### JIC 6030

#### Industrial Applications

##### [Characteristic]

This is an economical Non-Asbestos sheet that is compounded with high quality Non-Asbestos fiber and filler & synthetic rubber materials. Especially, it shows a decent quality in processing & sealing performance under water, hot water, mild acids and alkalis and building-fire-fighting pipe.

고기능 섬유와 보강성이 뛰어난 충전제, 합성고무를 사용한 시트로, 가공성이 매우 우수하며, 건축소방배관, 일반가스(공기), 물, 열수, 약산, 약알칼리 등에 적용이 가능한 경제적인 시트.

##### [Application]

Short-term peak Temp.	150°C [ 423°F ]
Maximum continuous Temp.	100°C [ 212°F ]
Short-term peak Pressure	40kgf/cm <sup>2</sup> [ 3.92 MPa ]

Applied Fluids : Air, Water, Hot Water, Salt Solution, Mild Acids and Alkalies.

##### [Service Range]

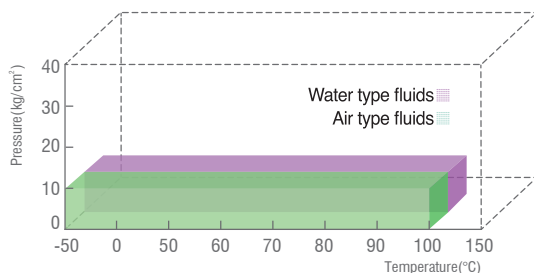

\*Maximum Temp. & Pressure combinations can not be used at the same time.

##### [Size]

Thickness(mm)	0.5 ~ 3.2
Sheet(mm)	1270×1270 / 1270×2540
	1270×3810 / 1520×1520
	2540×3810 / 1520×3040

\*Other Sizes can be available, if required.

\*One or both sides Graphite & PTFE coating available, if required.

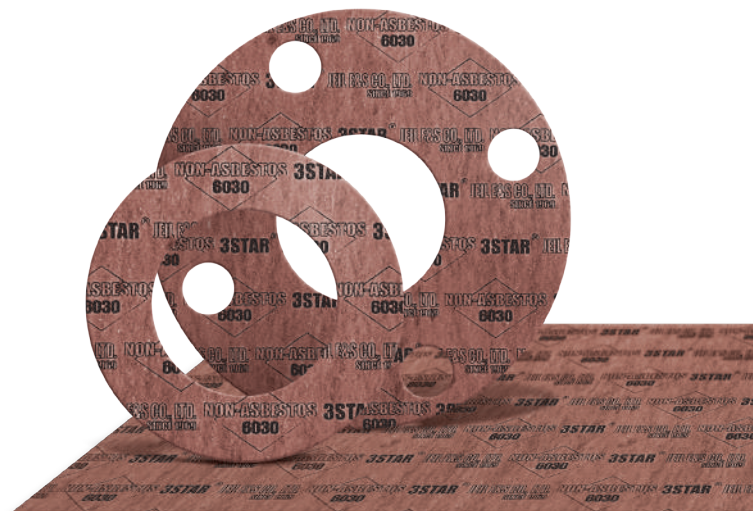

##### [Typical Physical Properties]

Test Method	Description	JIC 6030
	Density [ g/cm <sup>3</sup> ]	1.6
ASTM F152	Tensile strength Across grain.MPa (kgf/mm <sup>2</sup> )	7.8 (0.8)
ASTM F36J	Compressibility [ % ]	13
	Recovery [ % ]	55
ASTM F146	Fluid Resistance after 5hrs immersions	
	ASTM #3 oil (150°C) Thickness Increase [ % ]	11
	Tensile Loss [ % ]	40
ASTM F147	ASTM Fuel B (20~30°C) Thickness Increase [ % ]	10
	Weight Increase [ % ]	15
	Flexibility	No Crack
ASTM F495	Ignition Loss [ % ]	34
	850°C(1123°F) x 30min	

\*All data are typical values

##### [Design Data]

Thickness(mm)	Gasket Factor(m)	Min. Design Seating Stress (y) kgf/cm <sup>2</sup> (psi)
3.2	2.00	112 (1600)
1.6	2.75	260 (3700)
0.8	3.50	457 (6500)

##### Note

Water type fluids : For steam line, spiral wound gasket or graphite sheet gasket is recommended.

Gas type fluids : Do not use for toxic & explosive gas line

\*If properties out of guideline needed, Please contact our Technical Team.

## Non-Metallic Sheets & Gaskets

### Compressed Non-Asbestos Sheets & Gaskets

## Aramid Fiber + SBR

### JIC 6100

#### Industrial Applications

##### [Characteristic]

JIC-6100 is designed specifically to perform and seal more effectively than other Non-Asbestos sheet materials. This sheet provides superior heat resistance and excellent recovery because of unique blends of special Non-Asbestos fiber (Aramid Fiber) & fillers and SBR binder.

내열성 합성고무인 SBR과 내열성이 우수한 고품질의 섬유 (Aramid Fiber)를 사용하였으며, 내열성 및 복원성이 우수한 평윤형 시트.

##### [Application]

Short-term peak Temp.	350°C [ 662°F ]
Maximum continuous Temp.	220°C [ 428°F ]
Short-term peak Pressure	80kgf/cm <sup>2</sup> [ 7.85 MPa ]
<b>Applied Fluids :</b> Air, Water, Oils, Mild Acids and Alkali, Inert Gases, Fuels, Salt Solution, Lubricant.	

##### [Service Range]

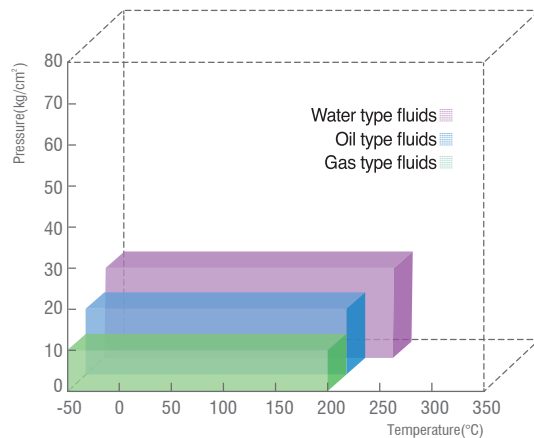

\*Maximum Temp. & Pressure combinations can not be used at the same time.

##### [Size]

Thickness(mm)	0.5 ~ 3.2
Sheet(mm)	1270×1270 / 1270×2540
	1270×3810 / 1520×1520
	2540×3810 / 1520×3040

\*Other Sizes can be available, if required.

\*One or both sides Graphite & PTFE coating available, if required.



##### [Typical Physical Properties]

Test Method	Description	JIC 6100
	Density [ g/cm <sup>3</sup> ]	1.7
ASTM F152	Tensile strength Across grain.MPa (kgf/mm <sup>2</sup> )	13.7 (1.4)
ASTM F36J	Compressibility [ % ]	10
	Recovery [ % ]	55
ASTM F146	Fluid Resistance after 5hrs immersions	
	ASTM #3 oil (150°C) Thickness Increase [ % ]	15
	Tensile Loss [ % ]	30
ASTM Fuel B (20~30°C)	Thickness Increase [ % ]	13
	Weight Increase [ % ]	17
	ASTM F147	Flexibility
ASTM F495	Ignition Loss [ % ]	30
	850°C(1123°F) x 30min	

\*All data are typical values

##### [Design Data]

Thickness(mm)	Gasket Factor(m)	Min. Design Seating Stress (y) kgf/cm <sup>2</sup> (psi)
3.2	2.00	112 (1600)
1.6	2.75	260 (3700)
0.8	3.50	457 (6500)

##### Note

Water type fluids : For steam line, spiral wound gasket or graphite sheet gasket is recommended.

Gas type fluids : Do not use for toxic & explosive gas line

\*If properties out of guideline needed, Please contact our Technical Team.



## Non-Metallic Sheets & Gaskets

### Compressed Non-Asbestos Sheets & Gaskets

## Aramid Fiber + NBR

### JIC 6200

#### Industrial Applications

##### [Characteristic]

High quality Non-Asbestos fiber (Aramid Fiber) and excellent heat & oil resistant rubber are compounded and calendered into a gasket sheet with superior chemical resistance. Especially it shows a good sealing performance under hot oil, oil gas, etc.

내열성이 우수한 고품질의 보강섬유(Aramid Fiber)와 내유성 및 내열성이 뛰어난 고무를 사용하여 우수한 화학적 안정성을 가진 내열용 시트로서, 특히 고온의 열유, 유가스 등의 기름에서 우수한 밀봉성을 발휘.

##### [Application]

<b>Short-term peak Temp.</b>	430°C [ 806°F ]
<b>Maximum continuous Temp.</b>	250°C [ 482°F ]
<b>Short-term peak Pressure</b>	100kgf/cm <sup>2</sup> [ 9.8 MPa ]
<b>Applied Fluids :</b> Water,Alkali,Salt Solution, Hot Oil, Oil Gas, Fuels below, Organic Solvents	

##### [Service Range]

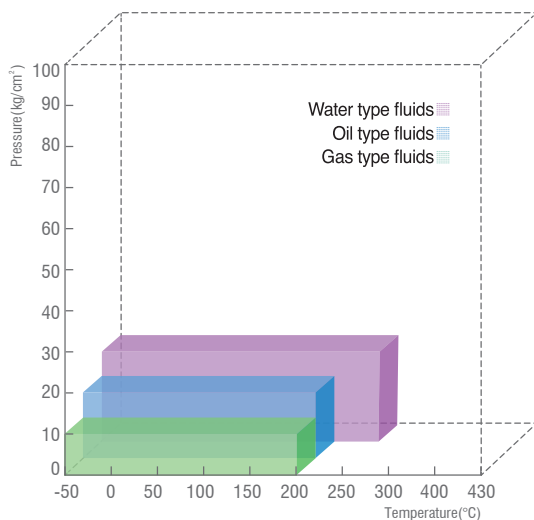

\*Maximum Temp. & Pressure combinations can not be used at the same time.

##### [Size]

<b>Thickness(mm)</b>	0.5 ~ 3.2
<b>Sheet(mm)</b>	1270×1270 / 1270×2540
	1270×3810 / 1520×1520
	2540×3810 / 1520×3040

\*Other Sizes can be available, if required.

\*One or both sides Graphite & PTFE coating available, if required.



##### [Typical Physical Properties]

Test Method	Description	JIC 6200
	Density [ g/cm <sup>3</sup> ]	1.7
ASTM F152	Tensile strength Across grain.MPa (kgf/mm <sup>2</sup> )	11.8 (1.2)
ASTM F36J	Compressibility [ % ]	10
	Recovery [ % ]	53
ASTM F146	Fluid Resistance after 5hrs immersions	
	ASTM #3 oil (150°C) Thickness Increase [ % ]	4
	Tensile Loss [ % ]	17
ASTM F147	ASTM Fuel B (20~30°C) Thickness Increase [ % ]	5
	Weight Increase [ % ]	8
	Flexibility	No Crack
ASTM F495	Ignition Loss [ % ]	28
	850°C(1123°F) x 30min	

\*All data are typical values

##### [Design Data]

Thickness(mm)	Gasket Factor(m)	Min. Design Seating Stress (y) kgf/cm <sup>2</sup> (psi)
3.2	2.00	112 (1600)
1.6	2.75	260 (3700)
0.8	3.50	457 (6500)

##### Note

Water type fluids : For steam line, spiral wound gasket or graphite sheet gasket is recommended.

Oil type fluids : For organic solvents, use below 150°C

Gas type fluids : Do not use for toxic & explosive gas line

\*If properties out of guideline needed, Please contact our Technical Team.

## Non-Metallic Sheets & Gaskets

### Compressed Non-Asbestos Sheets & Gaskets

## Carbon Fiber+NBR

### JIC 6400

#### Industrial Applications

##### [Characteristic]

This Non-Asbestos sheet, JIC-6400 provides superior chemical resistance and excellent heat resistance to use in steam and other high-temperature required lines. Suitable for a wide range of fluids like as fuel, lubricating, animal & vegetable oil, organic solvents, etc.

각종 화학적 저항성 및 내열성이 뛰어난 고기능 시트로서, 스팀 라인에 저항성을 가지며 고온라인에 적합하고, 연료유, 윤활유, 동식물유 및 유기용제 등 넓은 범위의 유체에 사용.

##### [Application]

Short-term peak Temp.	480°C [ 896°F ]
Maximum continuous Temp.	320°C [ 608°F ]
Short-term peak Pressure	100kgf/cm <sup>2</sup> [9.8 MPa ]

**Applied Fluids** : Lubricating Oil, Fuel, Animal Oil, Organic Solvents, etc / Water, Hot Water, Steam, Hot Oil, Oil Gas, Salt Solution.

##### [Service Range]

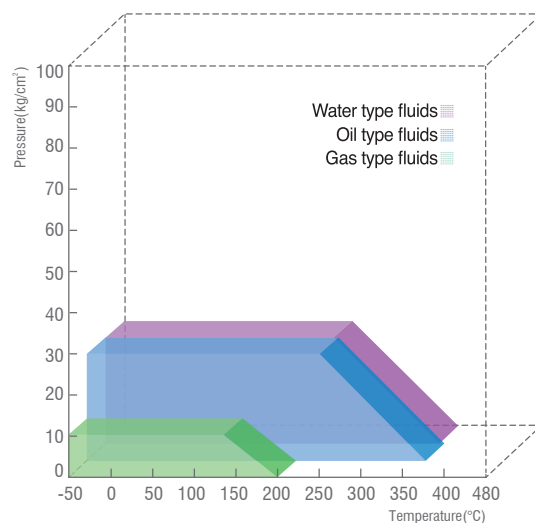

\*Maximum Temp. & Pressure combinations can not be used at the same time.

##### [Size]

Thickness(mm)	0.5 ~ 3.2
Sheet(mm)	1270×1270 / 1270×2540
	1270×3810 / 1520×1520
	2540×3810 / 1520×3040

\*Other Sizes can be available, if required.

\*One or both sides Graphite & PTFE coating available, if required.



##### [Typical Physical Properties]

Test Method	Description	JIC 6400
	Density [ g/cm <sup>3</sup> ]	1.8
ASTM F152	Tensile strength Across grain.MPa (kgf/mm <sup>2</sup> )	13.7 (1.4)
ASTM F36J	Compressibility [ % ]	9
	Recovery [ % ]	58
ASTM F146	Fluid Resistance after 5hrs immersions	
	ASTM #3 oil (150°C) Thickness Increase [ % ]	5
	Tensile Loss [ % ]	23
ASTM Fuel B (20~30°C)	Thickness Increase [ % ]	4
	Weight Increase [ % ]	9
	ASTM F147	Flexibility
ASTM F495	Ignition Loss [ % ]	26
	850°C(1123°F) x 30min	

\*All data are typical values

##### [Design Data]

Thickness(mm)	Gasket Factor(m)	Min. Design Seating Stress (y) kgf/cm <sup>2</sup> (psi)
3.2	2.00	112 (1600)
1.6	2.75	260 (3700)
0.8	3.50	457 (6500)

##### Note

Water type fluids : For steam line, please consult to our Technical Team in advance

Oil type fluids : For organic solvents, use below 150°C

Gas type fluids : Do not use for toxic & explosive gas line

\*If properties out of guideline needed, Please contact our Technical Team.



## Non-Metallic Sheets & Gaskets

### Compressed Non-Asbestos Sheets & Gaskets

## Carbon Fiber + NBR+Wire Reinforced

### JIC 6400W

#### Industrial Applications

##### [Characteristic]

This 6400W is excellent quality Non-Asbestos carbon fiber gasket material with stainless steel wire-mesh inserted to be suitable for exhaust line under high temperature and high pressure.

내열성이 우수한 고품질의 보강섬유(Aramid+Carbon Fiber)와 내유성 고무를 사용한 고성능 시트로써 시트 내부에 스테인레스 금망을 넣고 제작하여 고온 고압에 우수한 성능을 발휘하는 금망 입 보강시트.

##### [Application]

Short-term peak Temp.	500°C [ 932°F ]
Maximum continuous Temp.	350°C [ 662°F ]
Short-term peak Pressure	100kgf/cm <sup>2</sup> [ 9.8 MPa ]

**Applied Fluids :** Suitable for Water, Hot Oil, Oil Gas Alkali, Salt Solutions, Solvents, Etc. , Strong Acid and Alkali, Soluble Chemicals.

##### [Service Range]

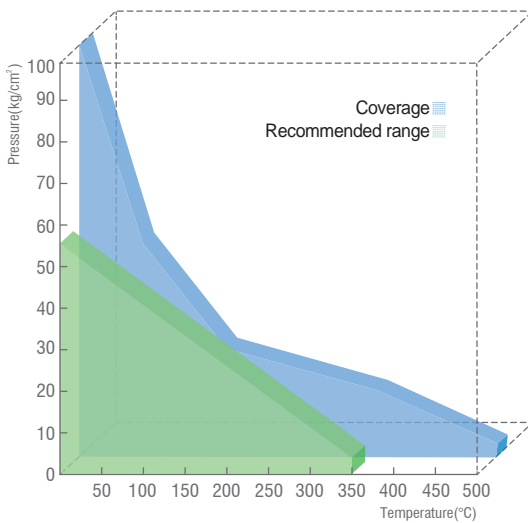

\*Maximum Temp. & Pressure combinations can not be used at the same time.

##### [Size]

Thickness(mm)	1.0 ~ 3.2
Sheet(mm)	1524×3100

\*Other Sizes can be available, if required.

\*One or both sides Graphite & PTFE coating available, if required.



##### [Typical Physical Properties]

Test Method	Description	JIC 6400W
	Density [ g/cm <sup>3</sup> ]	1.8
ASTM F152	Tensile strength Across grain.MPa (kgf/mm <sup>2</sup> )	17.7 (1.8)
ASTM F36J	Compressibility [ % ]	10
	Recovery [ % ]	57
ASTM F146	Fluid Resistance after 5hrs immersions	
	ASTM #3 oil (150°C) Thickness Increase [ % ]	4
	Tensile Loss [ % ]	16
ASTM F147	ASTM Fuel B (20~30°C) Thickness Increase [ % ]	3
	Weight Increase [ % ]	6
	Flexibility	No Crack
ASTM F495	Ignition Loss [ % ]	24
	850°C(1123°F) x 30min	

\*All data are typical values

##### [Design Data]

Thickness(mm)	Gasket Factor(m)	Min. Design Seating Stress (y) kgf/cm <sup>2</sup> (psi)
3.2	2.00	112 (1600)
1.6	2.75	260 (3700)
0.8	3.50	457 (6500)

##### Note

Water type fluids : For steam line, spiral wound gasket or graphite sheet gasket is recommended.

Oil type fluids : For organic solvents, use below 150°C

Gas type fluids : Do not use for toxic & explosive gas line

\*If properties out of guideline needed, Please contact our Technical Team.

## Non-Metallic Sheets & Gaskets

### Compressed Non-Asbestos Sheets & Gaskets

#### Aramid Fiber + Synthetic Rubber

### JIC 6210

#### Automotive Applications



#### [Characteristic]

JIC 6210 is designed for Automotive purposes. It shows excellent oil-resistance and recovery with the use of high quality fibers (Aramid Fiber) and NBR rubber binder.

내열성이 우수한 고품질의 보강섬유(Aramid Fiber)와 합성고무(Synthetic Rubber)를 사용하여 내유성 및 복원성이 우수한 자동차용 시트.

#### [Application]

**Applied Fluids :** Water, Hot Water, Oils, Mild Acids and Alkalis

#### Aramid Fiber + NBR

### JIC 6215

#### Automotive Applications

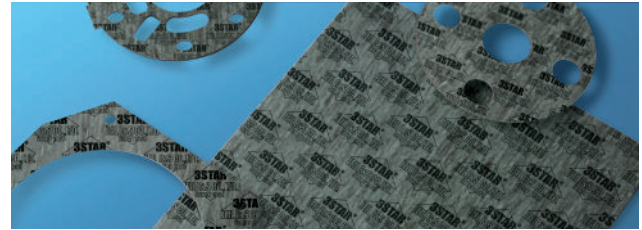

#### [Characteristic]

Same as JIC 6210, but this JIC 6215 is also suitable for fuel-resistant application.

내열성이 우수한 고품질의 보강섬유(Aramid Fiber)와 내유성 고무(NBR)를 사용하였으며 압축, 복원성이 우수하고 뛰어난 내유성, 내연료유성을 가진 자동차용 시트.

#### [Application]

**Applied Fluids :** Water, Air, Mild Acids and Alkalis, Salt Solution, Lubricant

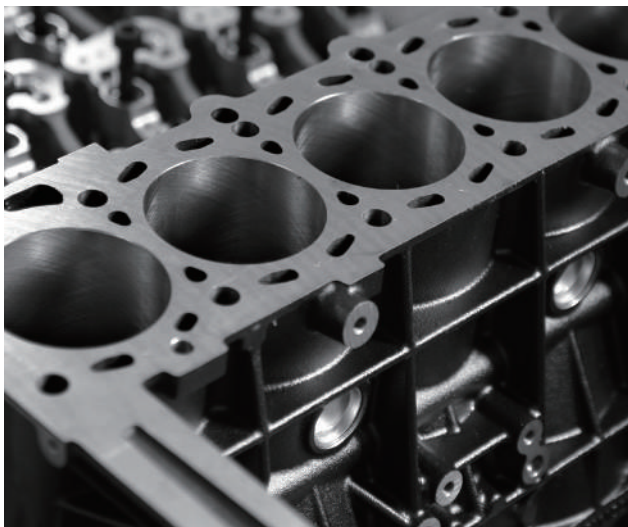
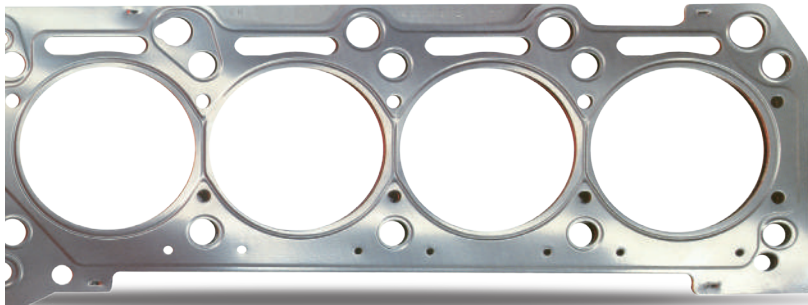

#### [Service Range]

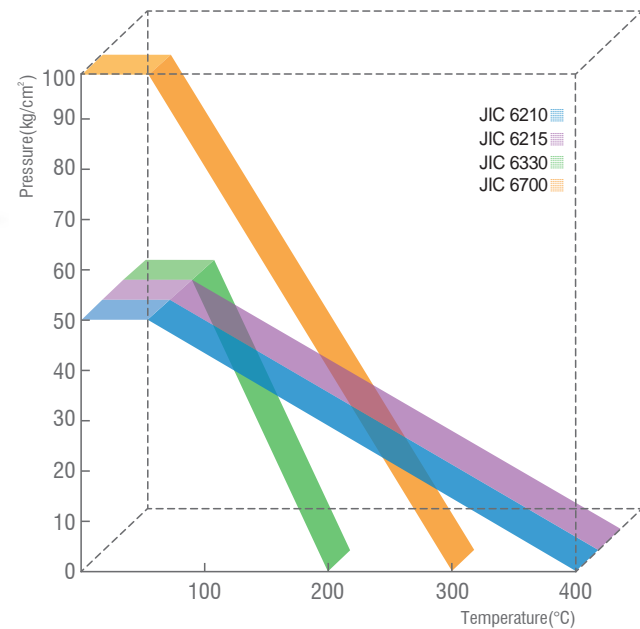

\*Maximum Temp. & Pressure combinations can not be used at the same time.



## Non-Metallic Sheets & Gaskets

### Compressed Non-Asbestos Sheets & Gaskets

## Aramid Fiber + Synthetic Rubber

### JIC 6330

#### Automotive Applications



#### [Characteristic]

This sheet has a self-swelling property to perform high pressure sealing performance in spite of low bolt force, which is compounded with excellent quality Aramid Fiber and SBR rubber binder.

내열성이 우수한 고품질의 보강섬유(Aramid Fiber)와 SBR고무를 사용한 시트이며, 팽윤성을 요구하는 라인에 사용되는 경제적인 시트.

#### [Application]

**Applied Fluids :** Water, Oil, Fuels, Salt Solution, Mild Acids and Alkalis

## Aramid Fiber + NBR

### JIC 6700

#### Automotive Applications



#### [Characteristic]

Special high quality fibers and oil resistant rubber are compounded and calendered into an Non-Asbestos gasket sheets. It shows very excellent properties in stress relaxation and tensile strength, etc.

고품질의 특수 섬유와 내유성고무를 사용하여 압연가열, 성형한 것으로 내구성 및 내연료유성이 매우 우수하며 응력완화율이 좋고 인장강도가 높은 시트.

#### [Application]

**Applied Fluids :** Water, Alkali, Salt Solution, Hot oil, oil Gas, Freon Gas Gas type Fluids

#### [Typical Physical Properties]

Test Method	Description	JIC 6210	JIC 6215	JIC 6330	JIC 6700
	Short-term peak Temp.(°C)	400°C (752°F)	400°C (752°F)	200°C (392°F)	300°C (572°F)
	Pressure MPa. (kgf/cm <sup>2</sup> )	4.9 (50)	4.9 (50)	4.9 (50)	9.8 (100)
	Density ( g/cm <sup>3</sup> )	1.7	1.7	1.7	1.7
ASTM F152	Tensile strength Across grain.MPa (kgf/mm <sup>2</sup> )	9.8(1.0)	13.7 (1.4)	9.8 (1.0)	15.7 (1.6)
ASTM F38	Creep Relaxation (%)	25	21	24	18
ASTM F36J	Compressibility (%)	12	8	13	9
	Recovery (%)	58	60	56	55
ASTM F146	Fluid Resistance after 5hrs immersions				
	ASTM No.3 5h / 150°C Thickness Increase (%)	7	2	17	5
	Tensile Strength Loss (%)	-	-	-	17
	Weight Increase	13	6	24	-
ASTM Fuel B	ASTM Fuel B 5h / 20~30°C Thickness Increase (%)	6	5	10	3
	Weight Increase (%)	10	5	16	5
	ASTM F495	Ignition Loss ( %) 850°C(1123°F)x30min	28	28	29

\* The Thickness of material tested 0.5mm for JIC 6210, 6215, 6330 and 6700  
\* All data are typical values

## Non-Metallic Sheets & Gaskets

### STARFOIL® Sheets & Gaskets

## STARFOIL® (Flexible Graphite) Sheets & Gaskets

### JIC 4201 Series

#### JIC 4201

Pure Graphite Sheet

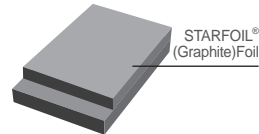

#### JIC 4201-P

Stainless Steel Flat Reinforced Graphite Sheet

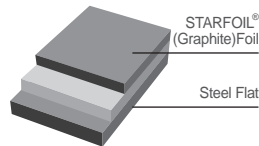

#### JIC 4201-B

Stainless Steel Tanged Reinforced Graphite Sheet

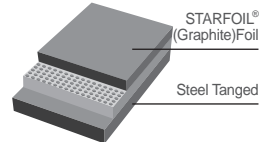

#### JIC 4201-W

Stainless Steel Wire-Mesh Reinforced Graphite Sheet

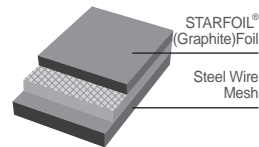

#### [Characteristic]

Expanded STARFOIL® gasket shows a good adherence to flange and performs a sealing performance even under low seating stress. There is no property change under temperature variation from cryogenic to High Temperature range. It shows good corrosive and chemical resistance. Various kinds of graphite gaskets such as stainless steel (wire-mesh, foil and tang) inserted types can be available in accordance with some special conditions.

흑연시트 가스켓은 플랜지와의 밀착성이 양호하여 낮은 체부면압에서도 밀봉성이 아주 뛰어나며 온도에 따른 재질 변화가 없으며 극저온에서부터 고온까지 다양하게 사용할 수 있으며, 해체시에도 쉽게 분리되며 내식성과 내약품성도 뛰어나 광범위하게 적용 가능. 순수 흑연시트의 취급 및 적용상의 단점을 보완하여 Stainless Steel(Wire, Plate, Tang)보강재입 흑연시트 가스켓을 적용한다.

#### [Application]

Temp.	-200°C ~ 450°C (Oxidizing Atmosphere Grade) -200°C ~ 525°C (Oxidation Resistant Grade) 650°C (in steam service)
pH range	0~14
Applied Fluids	High temperature & high pressure steam, hot water, gas, organic solvents, acid, alkali, LPG, LNG, Liquid N2. etc.

#### [Size]

Thickness(mm)	0.8 ~ 3.2
Sheet(mm)	1000×1000 / 1500×1500



#### [Typical Physical Properties]

Test Method	Description	JIC 4201	JIC 4201 - P,B,W
	Carbon Content		Min. 98%
	Ash Content		Max. 2%
	Leachable Chloride Content		Max. 50 ppm
	Sulfur Content		Max. 550 ppm
ASTM F36A	Compressibility[%]	40	35
	Recovery[%]	15	20
ASTM F38	Creep Relaxation[%]	< 5	< 5

#### [Design Data]

JIC No.	Gasket Factor(m)	Min. Design Seating Stress (y) kgf/cm <sup>2</sup> (psi)
JIC 4201 JIC 4201-P JIC 4201-W	2	63 (900)
JIC 4201-B	2	176 (2500)

#### Note

Gas type fluids : Do not use for toxic & explosive gas line  
\*If properties out of guideline needed, Please contact our Technical Team.





## Non-Metallic Sheets & Gaskets

### STARFOIL® Sheets & Gaskets

#### STARFOIL® (Flexible Graphite) Plain Tape

#### JIC 4204

#### STARFOIL® (Flexible Graphite) Crinkled Tape

#### JIC 4205

##### [Characteristic]

One side of STARFOIL® (Expanded Graphite) sheet is treated with adhesive and cut into tapes. Plain and Crinkled types can be provided. JIC-4204 is plain tape and JIC-4205 is crinkled tape.

STARFOIL®의 한쪽면에 접착제를 도포하여 Tape상으로 절단하여 사용하며 JIC 4205는 STARFOIL®의 한쪽면에 접착제를 도포하여 주름가공을 하여 테이프상으로 절단한 가스켓 테이프로서 평면Tape 및 주름가공Tape 두가지 형태가 있다.

##### [Application]

Mainly used for the cover to the surface of metal gaskets or flanges. Service temperature and pH range same as those of JIC 4201.

금속 가스켓 또는 플랜지면 등의 표면접착에 사용.

Temp.	-200°C~450°C (Non-Oxidizing Atmosphere) 650°C (in steam service)
pH range	0~14

##### [Size]

Thickness(mm)	Width(mm)	Length(M)
0.4 (0.38)	6.4	15
0.4 (0.38)	12.7	15
0.4 (0.38)	19.1	15
0.4 (0.38)	25.4	15

\*Other Sizes can be available, if required.

##### Note

Keep gaskets from damage/breakdown with care when transporting and using gaskets.

Do not recommend the use of gaskets under Strong Acid Fluids.

Do not recommend the use of gasket under high-temperature Oxygen Lines.

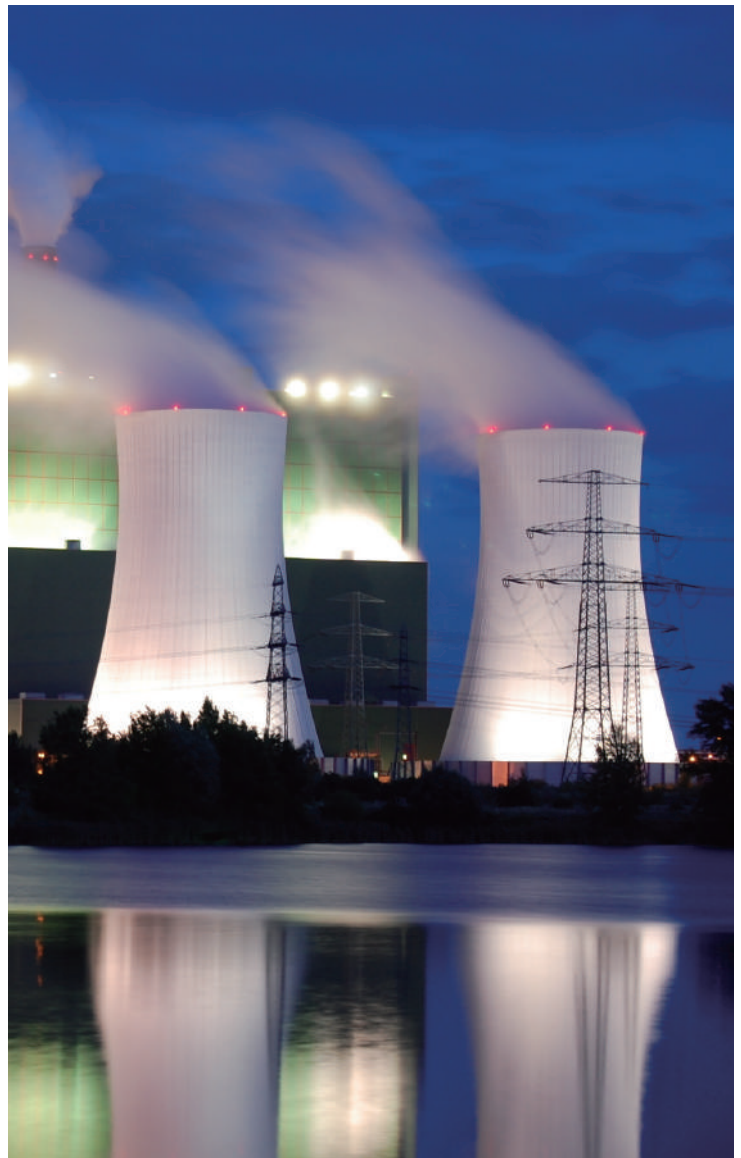
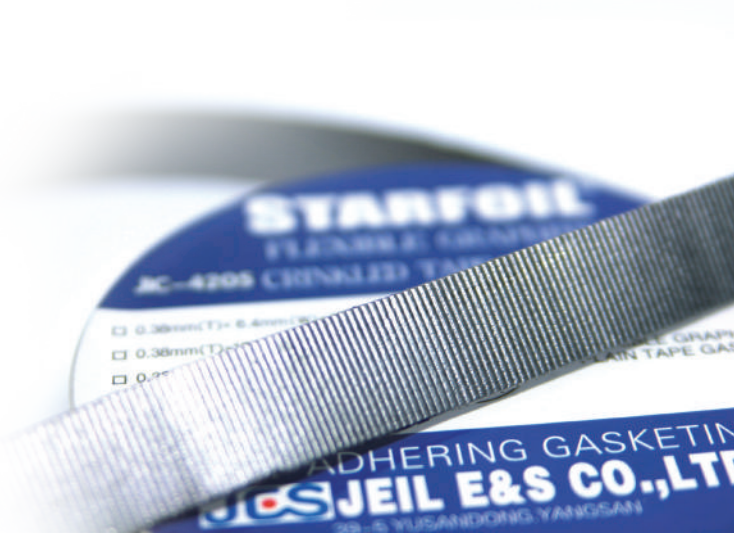

## Non-Metallic Sheets & Gaskets

### STARFLON® Sheets & Gaskets

## STARFLON® (PTFE) Solid Gasket

### JIC 8305

#### [Characteristic]

STARFLON® Solid Gasket, JIC 8305 is made into cut gaskets. It shows very excellent in chemical resistance. Carbon, Glass or other filler materials can be used for wide service applications.

내약품성이 현저히 우수한 4불화 에틸렌수지로 성형한 PTFE Sheet를 소정의 평면상으로 가공한 가스켓이다. Cold-Flow (크립현상)이 발생되기 쉬우므로, 적용시 유의하여야 한다.

#### [Application]

Maximum Service Temp.	100°C
Maximum Service Pressure	10kgf/cm <sup>2</sup>

**Applied Fluids :** Alkaline metallic organic chemical compounds, chemicals or solvents except fluorine under high temperature and high pressure, oil gas, foods and medicines to avoid fluid contamination.

#### [Size]

Thickness(mm)	0.5 ~ 0.3
Sheet(mm)	1000×1000 / 1500×1500

\*Other sizes can be available, if required.

#### [Typical Physical Properties]

Test Method	Description	Value
JIS K 7137	Density [ g/cm <sup>3</sup> ]	2.15
	Tensile strength.MPa (kgf/mm <sup>2</sup> )	23.2 (2.37)
	Elongation [ % ]	310

\*All data are typical values

#### [Design Data]

Material	Thickness (mm)	Gasket Factor(m)	Min. Design Seating Stress (y) kgf/cm <sup>2</sup> (psi)	Flange Surface
PTFE	1.5	3.2	230 (3271)	12.5 ~ 25S
	3.0	2.5	200 (2845)	

\*Pure PTFE Gasket can be applied to L.M&F flange, L.T&G flange

## STARFLON® (PTFE) Reinforced Gasket

### JIC 8305G

#### [Characteristic]

This JIC 8305G is very special STARFLON® Gasket that is reinforced with some filler materials such as Carbon or Glass, etc. to improve Cold-Flow Phenomenon as the weak point of Starflon Gasket.

4불화 에틸렌수지에 무기질 충전제 등을 사용하여 사용범위를 한층 더 넓은 보강형 제품으로, PTFE의 약점인 Cold-Flow (크립현상)을 개선하였으며, 내열, 내약품성을 가지고 있어 각종 화학약품을 취급하는 라인의 가스켓으로 적합하다.

#### [Application]

Maximum Service Temp.	200°C
Maximum Service Pressure	40kgf/cm <sup>2</sup>

**Applied Fluids :** Alkaline metallic organic chemical compounds, chemicals or solvents except fluorine under high temperature and high pressure, oil gas, foods and medicines to avoid fluid contamination.

#### [Size]

Thickness(mm)	1.0 ~ 3.0
Sheet(mm)	1000×1000 / 1270×1270

\*Other sizes can be available, if required.

#### [Typical Physical Properties]

Test Method	Description	Value
JIS K 7137	Density [ g/cm <sup>3</sup> ]	2.28
	Tensile strength.MPa (kgf/mm <sup>2</sup> )	14.7 (1.5)
	Elongation [ % ]	330

\*All data are typical values

#### [Design Data]

Material	Thickness (mm)	Gasket Factor(m)	Min. Design Seating Stress (y) kgf/cm <sup>2</sup> (psi)
PTFE	1.0	3.5	250 (3556)
	1.5	3.2	230 (3271)
	2.0	3.0	200 (2845)
	3.0	2.5	

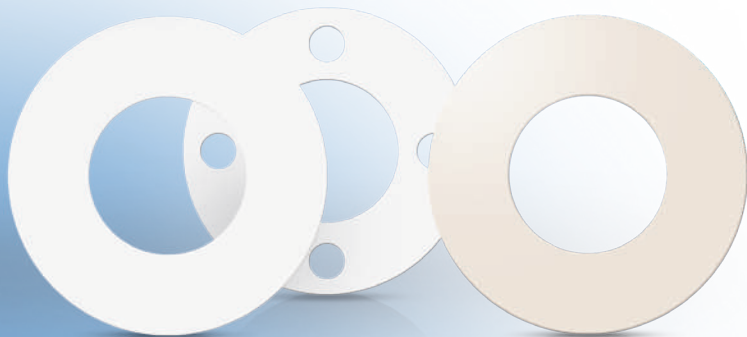



## Non-Metallic Sheets & Gaskets

### STARFLON<sup>®</sup> Sheets & Gaskets

## STARFLON<sup>®</sup> (PTFE) Enveloped Gasket

### JIC 8310

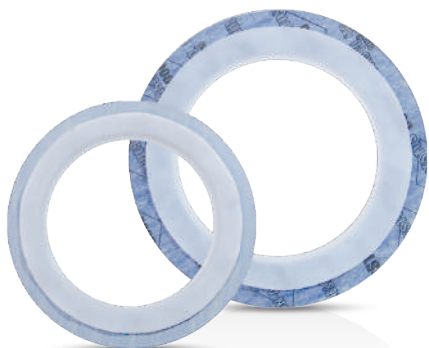

#### [Characteristic]

Elastic cushion materials (Compressed Non-Asbestos sheet, Rubber sheet) is enveloped with PTFE sheet into a gasket. Excellent in chemical resistance.

탄력있는 Cushion재(압축비석면판, 고무판 등)를 PTFE박판으로 피복한 가스켓으로 화학적 안정성이 뛰어나다.

#### [Application]

Maximum Service Temp.	150°C
Maximum Service Pressure	20kgf/cm <sup>2</sup>

**Applied Fluids :** Elastic enough to perform a sealability by low face pressure. Suitable for strong acid, strong alkali, low temperature fluid, oxygen, Cl<sup>2</sup> gas, organic solvents, corrosive fluid, etc.

#### [Design Data]

Gasket Type	Gasket Factor(m)	Min. Design Seating Stress (y) kgf/cm <sup>2</sup> (psi)
A	3.5	150 (2134)
B	4.0	200 (2845)
C	3.5	150 (2134)

#### [Standard Size]

KS 5K, 10K FLANGE / ANSI 150LB FLANGE

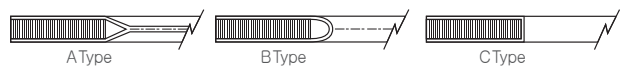

## STARFLON<sup>®</sup> (PTFE) Jacketed Gasket

### JIC 8313



#### [Characteristic]

Elastic cushion materials (Compressed Non-Asbestos sheet or Rubber sheet) is completely shielded into a gasket. This prevents the contamination of cushion materials from the fluid flow.

탄력있는 Cushion재(압축비석면판, 고무판 등)를 PTFE박판으로 피복하고 Out Dia. 쪽을 봉합한 가스켓이다. 외부로부터 유체가 침투하더라도 중심재의 오염을 방지할 수 있는 특징이 있다.

#### [Application]

Maximum Service Temp.	150°C
Maximum Service Pressure	20kgf/cm <sup>2</sup>

**Applied Fluids :** Strong acid, strong alkali, low temperature fluid, oxygen, Cl<sup>2</sup> gas, oil solvents, corrosive fluids.

#### [Design Data]

Gasket Type	Gasket Factor(m)	Min. Design Seating Stress (y) kgf/cm <sup>2</sup> (psi)
A	3.5	150 (2134)
B	4.0	200 (2845)
C	3.5	150 (2134)

#### [Standard Size]

KS 5K, 10K FLANGE / ANSI 150LB FLANGE



## Non-Metallic Sheets & Gaskets

### STARFLON® Sheets & Gaskets

# STARFLON® (PTFE) Expanded Sheet Gasket

## JIC 8312

### [Characteristic]

This Sheet Gasket is made from 100% expanded PTFE with multidirectional strength. Developed to come up with the problems of creep and cold flow. Excellent in chemical resistance and in the use and cut gasketing process.

내약품성이 현저히 우수한 4불화 에틸렌수지를 팽창성형한 특수 PTFE Sheet를 소정의 평면상으로 가공한 가스켓. 가공성이 뛰어나 어떠한 형태든지 직접 가공하여 적용개소에 설치가능하며 화학 약품을 취급하는 라인 및 비오염성 라인 등에 적용 가능.

### [Application]

Maximum Service Temp.	260°C
Maximum Service Pressure	20kgf/cm <sup>2</sup>

**Applied Fluids :** Alkaline metallic organic chemical compounds, chemicals or solvents except fluorine under high temperature and high pressure, oil gas, foods and medicines to avoid fluid contamination.

### [Size]

Thickness(mm)	0.5 ~ 9.0
Sheet(mm)	1000× 1000 / 1500× 1500

\*Other Sizes can be available, if required.



### [Typical Physical Properties]

Test Method	Description	Value
ASTM D792	Density (g/cm <sup>3</sup> )	0.65
ASTM F152	Tensile Strength .MPa	47.56 (13.7)
ASTM F36	Compressibility(%)	66
	Recovery(%)	7
ASTM F37B	Sealability Nitrogen(ml/hr)	0.17
ASTM F38	Creep relaxation(%)	37.1

\*All data are typical values

### [Design Data]

Thickness(mm)	Gasket Factor(m)	Min. Design Seating Stress (y) kgf/cm <sup>2</sup> (psi)
1.0	3.5	250 (3556)
1.5	3.2	230 (3271)
2.0	3.0	200 (2845)
3.0	2.5	

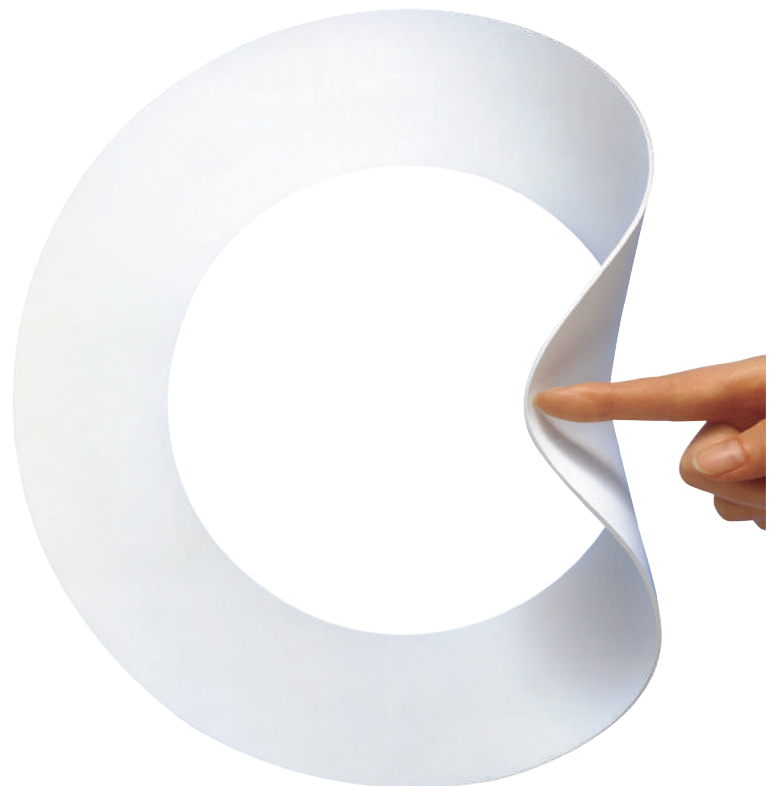

## Non-Metallic Sheets & Gaskets

### STARFLON® Sheets & Gaskets

# STARFLON® (PTFE) Expanded Joint Sealant Gasket

## JIC 6066

### [Characteristic]

This STARFLON® is an expanded, pure PTFE sealing material. From very conformable, flexible strip forms, using in applications involving non-standard flanges and harsh surface and places where the enough force cannot be given.

This has outstanding chemical resistance and is inherently clean, making the product particularly suitable for sealing against aggressive media or in situations where feedstock contamination may be of concern.

PTFE를 원료로 하여 화학성이 강한 곳에 사용되며, 강하고 질긴 성질을 가진 반면에 부드러운 성질을 가져 불균일한 표면이나 힘을 많이 가할 수 없는 곳에 끈을 연결하는 것과 같이 쉽게 사용이 가능.

### [Application]

Maximum Service Temp.	260°C
Maximum Service Pressure	20kgf/cm <sup>2</sup>

**Applied Fluids :** Chemical pipe, steam & heat exchanger, flange with rough surface & places where the strong bolting force is not available.

### [Size]

Width(mm)	Thickness(mm)	Length(M)
7.0	2.5	15
10.0	3.0	8
12.0	4.0	4.5
16.0	6.0	4.5
20.0	7.0	4.5
25.0	5.0	4.5
25.0	7.0	4.5



### Installation Instructions

- 1) Clean flange surface completely to ensure optimal adhesion.
- 2) Measure all sizes correctly.
- 3) Remove the adhesive backing tape.
- 4) Position sealant on the surface.
- 5) Finish install with overwrapping each ends as picture.

### PTFE Joint Sealant 장착방법

1. 장착부위의 Sealing면을 깨끗이 청소한다.
2. Joint Sealant를 장착부위에 올려 놓고 길이를 측정된 다음 절단한다.
3. Joint Sealant 뒷면 접착테이프 보호지를 떼어낸다.
4. 장착부위 Sealing면의 중앙에 Joint Sealant를 천천히 부착한다.
5. 최종마무리는 위 그림과 같이 서로 교차하여 처리한다.

### Size Selection Criteria

Flange Diameter	0 - 500 Ø	500 - 1000 Ø	1000 - 1500 Ø	Over 1500 Ø
Joint Sealant Size(mm)	3 - 9	6 - 12	9 - 16	12 - 19

\*Other sizes can be available as customer's requirements.



## Non-Metallic Sheets & Gaskets

### STARPITE® Sheets & Gaskets

## Stainless Steel Reinforced STARPITE® Sheet

### JIC 4201-HT

#### [Characteristic]

JIC-4201 HT is designed mineral material with stainless steel tanged reinforced to versatile demanding sealing application for chemical and temperature resistance. Especially, excellent in oxidation and chemical compatibility exceeds that of graphite and will successfully seal up to 1000°C

JIC-4201 HT 가스켓은 특수한 무기질 원료와 스테인리스가 보강되어 온도에 따른 변화가 없으며 최고 1832°F까지 사용할 수 있다. 내식성과 내약품성이 Graphite 보다 뛰어나며 산화에 강하여 광범위하게 사용가능. 원재료 특성상 Inner Jacketed Type을 권장함.

#### [Application]

<b>Maximum Service Temp.</b>	1000°C (1800°F)
<b>Maximum Tested Pressure (Inner Jacketed Type)</b>	30kgf/cm <sup>2</sup>
<b>Applied Fluids :</b> combustion engine exhaust, nitrogen fertilizer manufacturing, steam and other applications.	

\* Gas type fluids : Do not use for toxic & explosive gas line

#### [Size]

<b>Thickness range(inch)</b>	1/32", 1/16", 1/8"
<b>Sheet(mm)</b>	1000×1000 / 1000×1200

\* Other sizes can be available as customer's requirements.

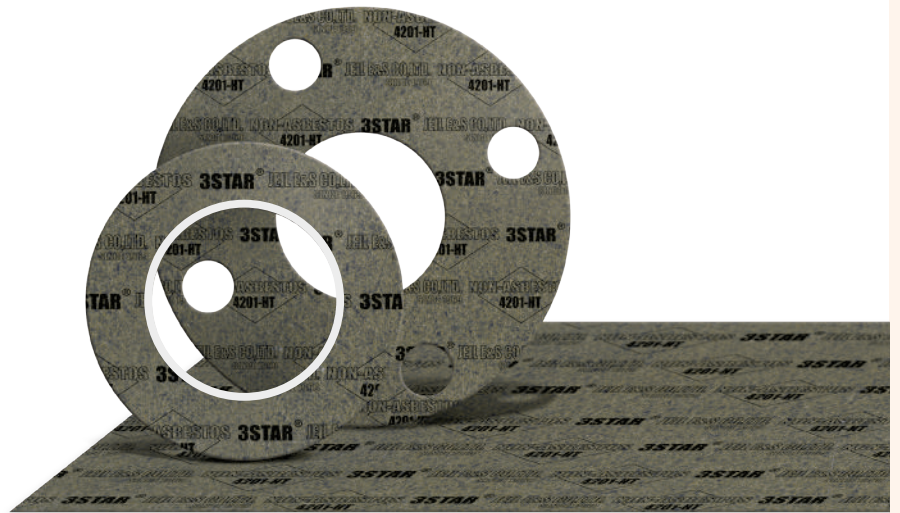

#### [Typical Physical Properties]

Test Method	Physical Properties	Typical Data (3.0t Base)
ASTM D792	Mica Density[g/cm <sup>3</sup> ]	1.9
ASTM F152	Tensile strength Across grain. MPa[kg/mm <sup>2</sup> ]	32.5[3.31]
ASTM F36J	Compressibility[%]	22
ASTM F36J	Recovery[%]	36
ASTM F495	Ignition Loss[%]	3
*DIN 3535-6	Gas Permeability[cc/min]	0.2
IEC 243-23°C	Dielectric Strength. kV/mm[V/mil]	20[508]

\* Gas Permeability Tested specimen : JIC 4201 - HT Inner Jacketed Type



## Non-Metallic Sheets & Gaskets

### Non-Metallic Sheets & Gaskets Description

#### [ Properties for Compressed Non-Asbestos Sheet Materials ]

Test Method	Description	JIC 6000	JIC 6100	JIC 6200	JIC 6400	JIC 6000W	JIC 6400W	JIC 6010	JIC 6030	JIC 6700	JIC 6210	JIC 6215	JIC 6330
	Density (g/cm <sup>3</sup> )	1.7	1.7	1.7	1.8	1.7	1.8	1.6	1.6	1.7	1.7	1.7	1.7
ASTM F152	Tensile Strength.MPa (kgf/mm <sup>2</sup> ) Across grain.	13.7 [1.4]	13.7 [1.4]	11.8 [1.2]	13.7 [1.4]	17.7 [1.8]	17.7 [1.8]	10.8 [1.1]	7.8 [0.8]	15.7 [1.6]	9.8 [1.0]	13.7 [1.4]	9.8 [1.0]
ASTM F36J	Compressibility [%]	9	10	10	9	9	10	11	13	9	12	8	13
	Recovery [%]	55	55	53	58	53	57	53	55	55	58	60	56
ASTM F146	Fluid Resistance after 5hrs immersions												
	Oil Resistance ASTM # 3 oil (150°C)												
	Thickness Increase [%]	5	15	4	5	5	4	6	11	5	7	2	17
	Tensile Strength Loss [%]	23	30	17	23	21	16	26	40	17			
	Weight Increase [%]								17		13	6	24
	Fuel Resistance ASTM Fuel B(20~30°C)												
	Thickness Increase [%]	5	13	5	4	3	3	5	10	3	6	5	10
	Weight Increase [%]	9	17	8	9	11	6	13	15	5	10	5	16
ASTM F147	Flexibility(F ≤ 12)	No Break	No Break	No Break	No Break	No Break	No Break	No Break	No Break	No Break	No Break	No Break	No Break
ASTM F495	Ignition Loss [%] 850°C (1123°F) x 30min	29	30	28	26	25	24	31	34	35	28	28	29
Standard Size	Thickness [mm]	0.5~3.2				1.0~3.2		0.5~3.2		0.35~2.0			
	Sheet Size [mm]	1270× 1270, 1270× 2540 1270× 3810, 1520× 1520 2540× 3810, 1520× 3040				1524× 3100		1270× 1270 1270× 2540 1270× 3810 1520× 1520 2540× 3810 1520× 3040		1220× 1240, 1220× 1870 1220× 3730, 1270× 1270 1270× 2540,			
Application		KS L 5406 , JIS R 3453, ASTM F 104											

- Thickness of material tested 1.5mm (except, JIC 6000W, 6400W : 3.0mm).
- Thickness of material tested 0.5mm for JIC 6210, 6215, 6330 & 6700
- Other thickness can be available as customer's requirements.
- All data are typical values.

#### [ Gasket Design Data ]

Thickness (mm)	Gasket Factor (m)	Min. Design Seating Stress (y) kgf/cm <sup>2</sup> (psi)
3.0(1/8")	2.00	112 (1600)
1.5(1/16")	2.75	260 (3700)
1.0(1/32")	3.50	457 (6500)

#### Note

Maximum Temp. & Pressure combinations can not be used simultaneously.  
If properties our of guideline needed, contact our Technical Team.  
Do not recommend the use of gaskets under noxious & explosive Gas lines applications.  
When the use of Steam Line, make sure to refer to Notice or contact our Technical Team.



# Non-Metallic Sheets & Gaskets

## Non-Metallic Sheets & Gaskets Description

### [ How to handle and use compressed Non-Asbestos Gaskets ]

#### 1. Selection of Optimum Sheet

Considering working conditions (temperature, corrosiveness, test & working pressure, flange type, gasket width etc), optimum gasket materials should be selected.

##### 재질의 선정

사용조건(사용유체의 종류, 사용온도, 압력, 플랜지 형상, 가스켓 폭 등)에 적합한 재질을 선정한다.

#### 2. Precautions in Mounting

- The roughness of flange surfaces should be above 25S.
- Flange surfaces should be neither contaminated nor damaged.
- Flange surfaces should be parallel without deformation and the center should not be deformed.
- Keep flange surfaces clean and then mount the gaskets in correct position.
- Tighten the flange bolts in order illustrated below.

##### 가스켓 장착시의 주의사항

- 플랜지 면의 조도는 25S 이상으로 한다.
- 플랜지 면에 이물질이 부착되어 있거나 플랜지면이 훼손되어서는 안 된다.
- 플랜지 면에 비틀림이 없어야 하며 평행하고 중심이 틀어지지 않아야 한다.
- 가스켓은 플랜지면을 깨끗이 한 후에 정확한 위치에 장착시켜야 한다.
- Bolting은 아래와 같이 순서적으로 실시해야 한다.

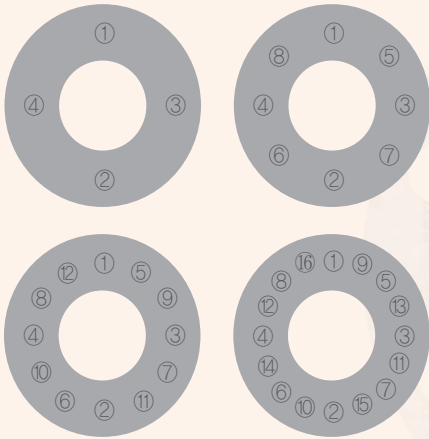

- When spreading gasket paste for the application of anti-stick or gas leakage protection, the paste should be spread thinly and uniformly.
- Be sure to retighten the flange bolts before operation.
- When handling fabric sheets, do not bring them in contact with sea water or touch them with sweaty hands.
- 소부 방지 및 Gas 누설방지 목적으로 가스켓에 페이스트를 도포할 때는 가능한 얇고, 고르게 도포를 한다.
- 운전하기 전 반드시 재 조임을 실시하며, 재조임은 상온, 상압에서 실시한다.

#### 3. Storage

- Avoid exposing the gasket sheets to direct sunlight, oxygen or ozone : store them in a cool, dark and clean places.
- Store gasket sheets on a level base in a flat condition without folding, hanging or rolling. If necessary, roll up gasket sheets in diameter as large as possible and place them horizontally without standing vertically.
- Put the remained gasket sheets in PE packing paper and store them.
- First-in & First-out : Pile up old sheets on new sheets and ship out sheets in advance.

##### 보 관

- 직사광선을 피하고 습기와 먼지가 없는 서늘한 장소에 보관한다.
- 보관시에는 시트를 접거나 매달거나 말지를 말고 평행하게 가로로 펴서 적재한다. 부득이 말은 제품은 세우지 말고 눕혀서 보관하여 권지경은 가능한 한 크게 한다.
- 일부분을 사용하고, 남은 제품은 별도의 덮개를 사용하여 외부에 직접 노출되지 않도록 한다.
- 선입선출 : 새로 들어온 것은 아랫쪽에 적재를 하고, 오래된 것은 위쪽에 적재를 하여 오래된 것을 먼저 사용토록 한다.

#### 4. Precautions use in Steam Line

- Use a cross bolting pattern in incremental steps, then go bolt-to-bolt with apply even load all round bolts in accordance with bolting work- process.
- Tighten bolts up to 400kg/cm<sup>2</sup> and use 1.5mm thick flat ring type gasket to apply sufficient load under same bold torque.
- Bolting process recommended to do under normal temperature and pressure.
- Spiral Wound Gasket & Reinforced Graphite Sheet Gasket are much suitable for Steam Line application.

##### Steam Line 사용상의 주의사항

- 가스켓 체결작업 시 균일한 체부면압이 전달될 수 있도록 Gasket 장착 절차서를 준수한다.
- 가스켓 체부면압이 400kg/cm<sup>2</sup> 이상으로 체부하고 동일한 Bolt Torque하에서 높은 체부력이 전달될 수 있도록 Gasket Type을 Flat Ring 으로 적용하고 두께는 1.5T(mm)로 한다.
- Bolt 재조임은 반드시 상온, 상압 상태에서 실시한다.
- Steam Line 적용 시에는 가스켓을 Reinforced Graphite Sheet Gasket 또는 Spiral Wound Gasket의 사용을 권장한다.



# Semi-Metallic Gaskets

**Spiral Wound Gaskets**

**High Temperature Spiral Wound Gaskets**

**Metal Jacketed Gaskets**

**Kammprofile Gaskets**

STARFOIL®, STARFLON®, STARPITE® & STARTEC™ are registered Trademark of JEIL E&S



## Semi-Metallic Gaskets

### Spiral Wound Gaskets

## STARFOIL® (Flexible Graphite) Filled Type | 흑연 필라입

<b>JIC 380□-SF</b>	Basic Type (기본형)
<b>JIC 380□-R-SF</b>	Inner Ring Type (내륜형)
<b>JIC 383□-SF</b>	Outer Ring Type (외륜형)
<b>JIC 383□-R-SF</b>	Inner-Outer Ring Type (내/외륜형)

#### [Characteristic]

This spiral wound gasket is manufactured by spirally winding a preformed V-shaped metal strip and flexible **STARFOIL®** (graphite) filler on the outer periphery under tension properly. Varying metallic inner & outer rings can be attached as required by operating conditions and applications with a variety of winding metal materials. Widely used in the chemical, petrochemical, oil refining, gas, power plant, various pipe flanges, heat-exchangers and shipbuilding

금속박판(Metal Winding)과 팽창흑연 필러를 단면 V자형으로 감아서 제작한 가스켓으로서 극저온에서 고온, 고압까지 석유정제, 화학, 전력, 가스, 선박과 각종 배관용 플랜지, 열 교환기 등 광범위하게 적용.

#### [Application]

<b>Maximum Service Temp.</b>	450°C
<b>Maximum Pressure Range</b>	Class 150 to 2500
<b>Applied Size</b>	ASME B16.20 / JIS B2404 KS B1518 / JPI 7S-41

\* Maximum Temperature & pressure combinations can not be used at the same time.

#### Note

- Do not recommend the use of gaskets under strong acid and oil gas (under high temperature) applications.
- Inner rings are mandatory for the use at raised face, full face, male & female flanges to prevent damages to the gasket bore and inner windings.

## Non-Asbestos Filled Type

| 비석면 필라입

<b>JIC 380□-NA</b>	Basic Type (기본형)
<b>JIC 380□-R-NA</b>	Inner Ring Type (내륜형)
<b>JIC 383□-NA</b>	Outer Ring Type (외륜형)
<b>JIC 383□-R-NA</b>	Inner-Outer Ring Type (내/외륜형)

#### [Characteristic]

This spiral wound gasket is manufactured by spirally winding a preformed V-shaped metal strip and non-asbestos filler on the outer periphery under tension properly. Varying metallic inner & outer rings can be attached as required by operating conditions and applications with a variety of winding metal materials. Suitable for use in the chemical & petrochemical industries and various pipe flanges, etc.

금속박판(Metal Winding)과 비석면 무기질 재료를 단면 V자형으로 감아서 제작한 가스켓으로서 기존의 석면 필러를 대체 적용하여 석유정제, 화학, 각종 배관용 플랜지 등에 광범위하게 적용.

#### [Application]

<b>Maximum Service Temp.</b>	400°C
<b>Maximum Pressure Range</b>	Class 150 to 2500
<b>Applied Size</b>	ASME B16.20 / JIS B2404 KS B1518 / JPI 7S-41

\* Maximum Temperature & pressure combinations can not be used at the same time.

#### Note

- Inner rings are mandatory for the use at raised face, full face, male & female flanges to prevent damages to the gasket bore and inner windings.

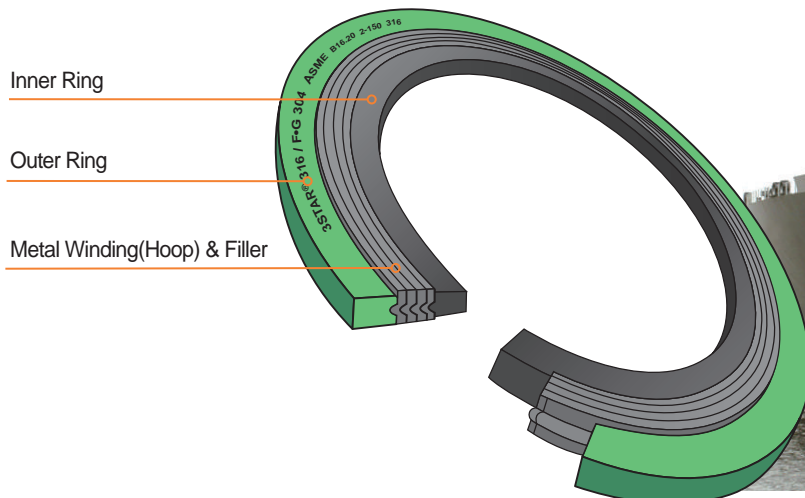

## Semi-Metallic Gaskets

### Spiral Wound Gaskets

## STARFLON® (PTFE) Filled Type

| PTFE 필라입

<b>JIC 380□-TF</b>	Basic Type (기본형)
<b>JIC 380□-R-TF</b>	Inner Ring Type (내륜형)
<b>JIC 383□-TF</b>	Outer Ring Type (외륜형)
<b>JIC 383□-R-TF</b>	Inner-Outer Ring Type (내/외륜형)

#### [Characteristic]

This spiral wound gasket is manufactured by spirally winding a preformed V-shaped metal strip and **STARFLON®** (PTFE) filler on the outer periphery under tension properly. Varying metallic inner & outer rings can be attached as required by operating conditions and applications with a variety of winding metal materials. Superior in chemical resistance.

Suitable for use in the chemical plants, oxygen pipe lines, LPG lines and other pipe flanges for chemical resistance.

금속박판(Metal Winding)과 불소수지(PTFE) 필러를 단면 V자형으로 감아서 제작한 가스켓으로서 내약품성이 뛰어나며 화학공장, 산소배관, LPG, 각종 내약품성 배관용 플랜지 등에 광범위하게 적용.

#### [Application]

<b>Maximum Service Temp.</b>	260°C
<b>Maximum Pressure Range</b>	Class 150 to 2500
<b>Applied Size</b>	ASME B16.20 / JIS B2404 KS B1518 / JPI 7S-41

\* Maximum Temperature & pressure combinations can not be used at the same time.

#### Note

- Inner rings are mandatory for the use at raised face, full face, male & female flanges to prevent damages to the gasket bore and inner windings.



#### [Spiral Wound Gaskets Types]

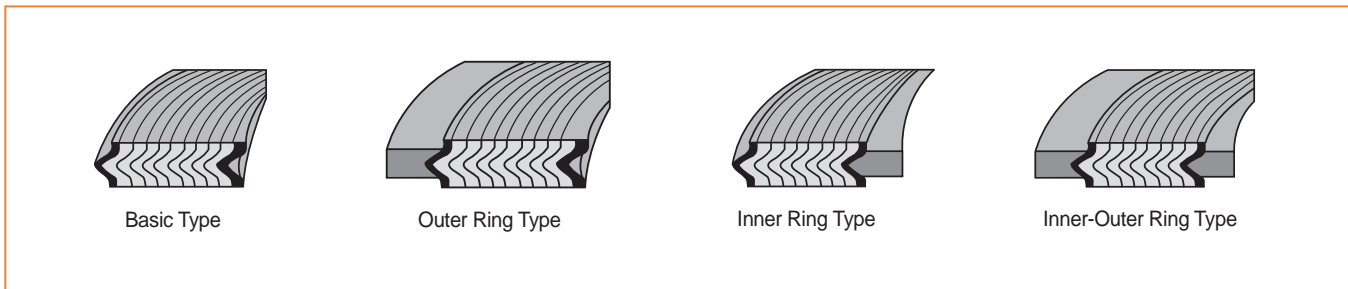



## Semi-Metallic Gaskets

### High Temperature Spiral Wound Gaskets

## Multi-Filler Filled Type

| 비석면 필라입+흑연 필라입/세라믹 필라입+흑연 필라입

**JIC 380□-Multi-filler** Basic Type (기본형)

**JIC 380□-R-Multi-filler** Inner Ring Type (내륜형)

**JIC 383□-Multi-filler** Outer Ring Type (외륜형)

**JIC 383□-R-Multi-filler** Inner-Outer Ring Type (내/외륜형)

This is a spiral wound gasket utilizing a combination of fillers (non-asbestos & STARFOIL® (flexible graphite)) to give excellent sealing performance at critical high temperature applications. Flexible STARFOIL® is susceptible to degradation due to oxidation when exposed under air or other oxidizing media. This multi-filler spiral wound gasket protects the STARFOIL® and shields it from contact of oxidizers without any loss in STARFOIL®.

#### [Characteristic]

Very Special structure in multi-fillers as Non-asbestos (NA) / Ceramic (CE)+STARFOIL®+Non-asbestos(NA) / Ceramic(CE) to protect STARFOIL® from oxidation and degradation.

Each 3 times NA/CE windings around inside & outside of STARFOIL® filler SUS 316, hoop material is mandatory at over 500°C conditions. But, maximum temperature & pressure combinations cannot be used at the same time.

금속박판(Metal Winding)과 STARFOIL® (Flexible Graphite) 본체의 내·외주 부분에 비석면 필러 또는 세라믹을 조합하여 이루어진 것으로서, 내부 유체 및 외부 공기에 의한 STARFOIL® 이 산화되어 소실되는 현상을 방지하기 위하여 STARFOIL® 본체의 내·외주 부분에 비석면 필러를 3회 이상 감은 형태로 이루어져 있다. STARFOIL® 단독으로는 사용하지 않는 고온, 고압용 라인에 사용가능한 Spiral Wound 가스켓.

#### [Application]

Maximum Service Temp.	600°C
Maximum Pressure Range	Class 150 to 2500
Applied Size	ASME B16.20 / JIS B2404 KS B1518 / JPI 7S-41

Suitable for the use at high temperature(over450°C)/pressure application to protect the STARFOIL® from oxidation in air or using fluids.

\* Maximum Temperature & pressure combinations can not be used at the same time.



#### [Structure]

•Non-asbestos filled+STARFOIL®+Non-asbestos filled(NA+SF+NA)

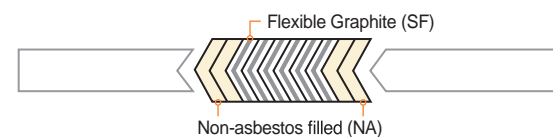

•Non-asbestos filled+STARFOIL®(NA+SF)

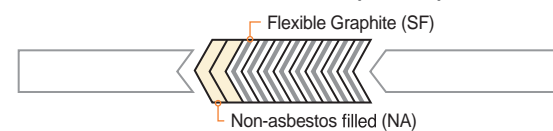

•Ceramics filled+STARFOIL®+Ceramics filled(CE+SF+CE)

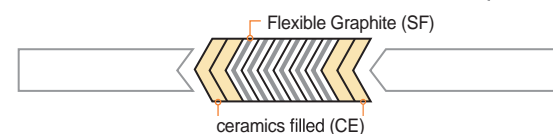

#### Note

- Inner rings are mandatory for the use at raised face, full face, male & female flanges to prevent damages to the gasket bore and inner windings.
- Do not recommend the use of outer ring to keep gasket body from distorting when it bolted.

## Semi-Metallic Gaskets

### High Temperature Spiral Wound Gaskets

## STARPITE® Filled Type

| STARPITE® 필라입

<b>JIC 380□-HT</b>	Basic Type (기본형)
<b>JIC 380□-R-HT</b>	Inner Ring Type (내륜형)
<b>JIC 383□-HT</b>	Outer Ring Type (외륜형)
<b>JIC 383□-R-HT</b>	Inner-Outer Ring Type (내/외륜형)

#### [Characteristic]

This **STARPITE®** spiral wound gasket is designed to use at extremely high temperature applications and has been replacing asbestos filled spiral wound gaskets which are being phased out. This can be used in up to 1000°C with very excellent sealing performance and chemical compatibility in totally free from oxidation.

금속박판(Metal Winding)과 STARPITE® Filler를 단면 V자형으로 감아서 제작한 가스켓으로서 석면 Filler 대체와 STARFOIL®를 적용할 수 없는 개소의 고온 라인에 적용 가능한 가스켓으로서 고온에서의 산화작용 없이 열적 안정성과 뛰어난 내화확성을 가지고 있는 제품.

#### [Application]

<b>Maximum Service Temp.</b>	1000°C
<b>Maximum Pressure Range</b>	Class 150 to 2500
<b>Applied Size</b>	ASME B16.20 / JIS B2404 KS B1518 / JPI 7S-41

\* Maximum Temperature & pressure combinations can not be used at the same time.

#### Note

- Inner rings are mandatory for the use at raised face, full face, male & female flanges to prevent damages to the gasket bore and inner windings.
- Wide range of metals available.
- At max. 1000°C : Inconel materials recommended.
- At max. 870°C : Stainless steel 321 or 347 shall be available.

#### [Structure]

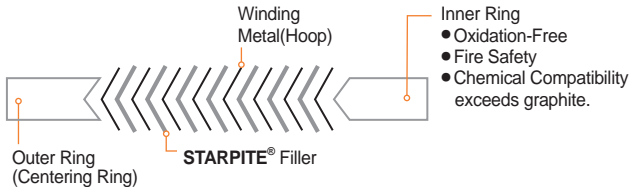

## Multi-Filler Filled Type (HTG)

| STARPITE® 필라입+흑연 필라입

<b>JIC 380□-HTG</b>	Basic Type (기본형)
<b>JIC 380□-R-HTG</b>	Inner Ring Type (내륜형)
<b>JIC 383□-HTG</b>	Outer Ring Type (외륜형)
<b>JIC 383□-R-HTG</b>	Inner-Outer Ring Type (내/외륜형)

#### [Characteristic]

This is spiral wound gasket winding **STARFOIL®** filler in the middle of **STARPITE®** filler of JIC 3808-HT Series gaskets to improve the sealing performance.

JIC 3808-HT Series 제품에 STARFOIL® Filler를 STARPITE® Filler 중간에 감아서 씰링성을 보강한 제품.

#### [Application]

<b>Maximum Service Temp.</b>	800°C
<b>Maximum Pressure Range</b>	Class 150 to 2500
<b>Applied Size</b>	ASME B16.20 / JIS B2404 KS B1518 / JPI 7S-41

\* Maximum Temperature & pressure combinations can not be used at the same time.

#### Note

JIC 3808-HTG is better in sealing performance than JIC 3808-HT but, low operating temperature required due to STARFOIL® oxidation.

#### [Structure]

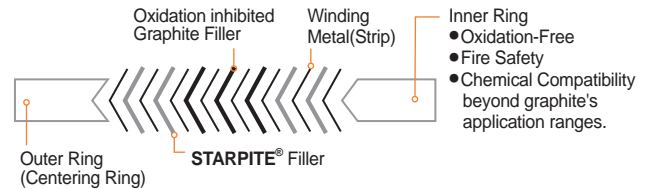

## Semi-Metallic Gaskets

### Metal Jacketed Gaskets

#### Non-Asbestos Filled (NA) Filler

**JIC 3840-NA** Double Jacketed Type (전피복형)

**JIC 3841-NA** Double Shell Type (이중피복)

**JIC 3860-NA** Double Jacketed Corrugated type (파형피복형)

##### [Characteristic]

This Metal Jacketed Gaskets consist of a metallic outer shell with non-asbestos filler inside. The metal jacket protects the filler and resists pressures, temperature and the filler material gives the gasket resilience. A wide range of materials are available in accordance with the relevant temperature and corrosive conditions. They are used for heat exchanger applications with pass partition bars.

비석면보드를 충전재로 박판금속을 피복재로 제작한 가스켓이다. 원형 혹은 비원형 형태로 제작 가능하고, 열교환기용으로 보통 가지가 부착된다. 피복재로는 여러가지 재질의 금속이 사용 가능.

##### [Application]

Maximum Service Temp.	530°C
Maximum Service Pressure	60kgf/cm <sup>2</sup>
Heat exchanger, High-pressure vessels, Boiler, Pumps, Valve bonnet, etc.	
<b>Applied Fluids:</b> Steam, Lubricants, Hydrocarbon, Water, Hot water, Organic solvents, Cryogenic line, Oxygen gas, Low temperature gases, LPG, etc.	

#### Ceramic (CE) Filler

**JIC 3840-CE** Double Jacketed Type (전피복형)

**JIC 3841-CE** Double Shell Type (이중피복)

**JIC 3860-CE** Double Jacketed Corrugated type (파형피복형)

##### [Characteristic]

This Gaskets using Ceramic filler with metallic outer shell. "CE" means a ceramic board which resists temperature up to 1300°C. JIC no. 3840-CE is ceramic board completely covered with stainless steel such stainless steel 304 or 316, etc in a flat shape. JIC 3860-CE is corrugated jacket type, specially designed for goose neck spherical joints which may be considered as most difficult to seal.

"CE" 는 1300°C까지 견디는 세라믹(Ceramic)이 충전재로 사용되었음을 뜻한다. JIC No. 3840-CE는 세라믹보드를 금속박판으로 피복하여 제작한 평면형 가스켓이다. JIC No. 3860-CE는 파형으로, 보다 까다로운 설성이 요구되는 원형관 이음등에 설계 제작.

##### [Application]

Maximum Service Temp.	1300°C
Short-term peak Pressure	60kgf/cm <sup>2</sup>
Goose neck of blast furnace, Heat exchanger, Naphtha cracking furnace, Valve bonnet, etc.	

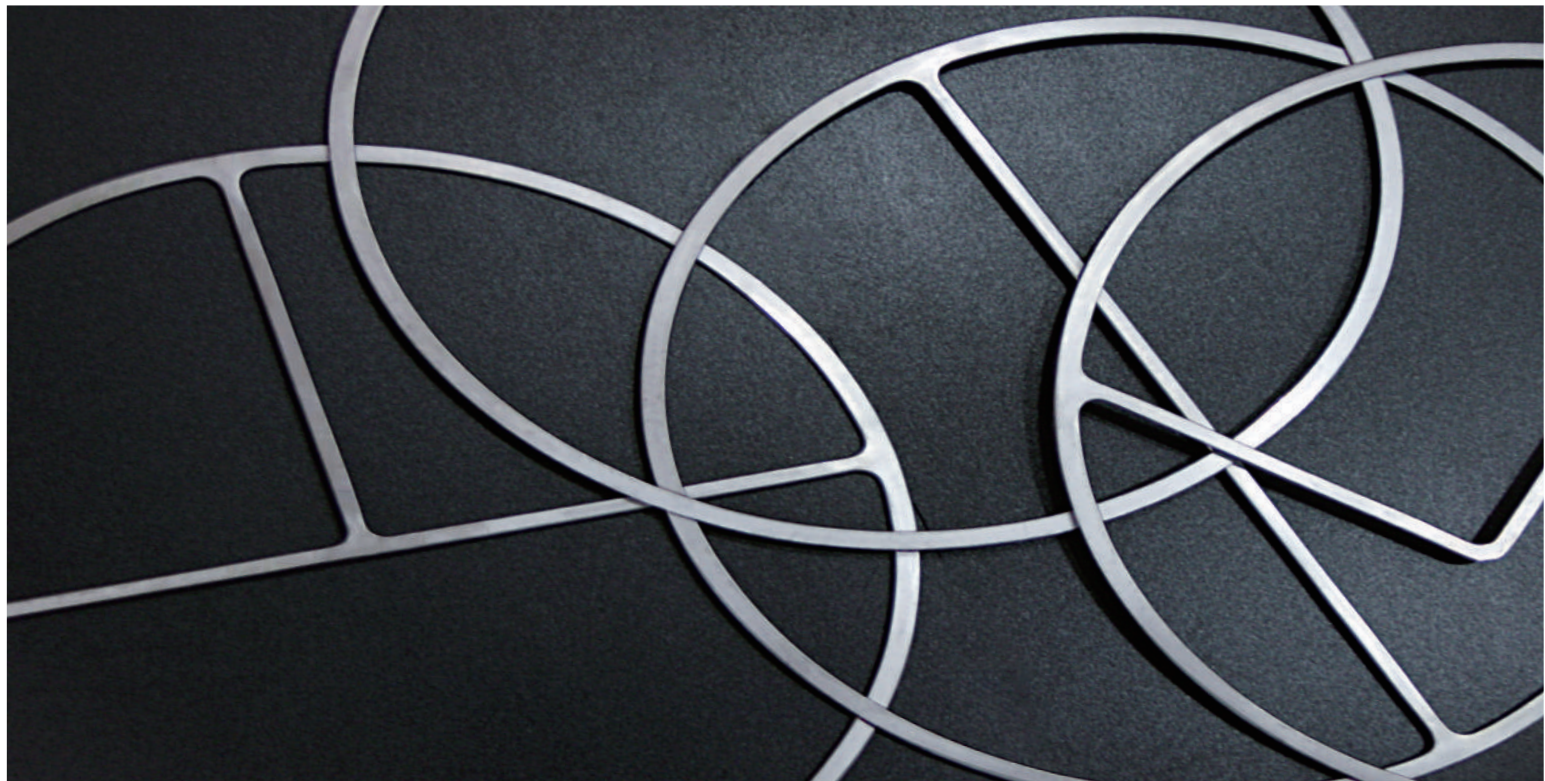



## Semi-Metallic Gaskets

### Metal Jacketed Gaskets

## STARFOIL® (SF) Filler

- JIC 3840-SF** Double Jacketed Type (전피복형)  
**JIC 3841-SF** Double Shell Type (이중피복)  
**JIC 3860-SF** Double Jacketed Corrugated type (파형피복형)

#### [Characteristic]

Same as JIC 3840-NA Series, but its filler material is **STARFOIL®**. A wide range of materials are available in accordance with the relevant temperature and corrosive conditions. They are used for heat exchanger applications with pass partition bars.

흑연을 충전재로 박판금속을 피복재로 제작한 가스켓이다. 원형 혹은 비원형 형태로 제작 가능하고, 열교환기용으로 보통 가지가 부착된다. 피복재로는 여러가지 재질의 금속이 사용 가능.

#### [Application]

<b>Maximum Service Temp.</b>	530°C
<b>Short-term peak Pressure</b>	60kgf/cm <sup>2</sup>

Heat exchanger, High-pressure vessels, Boiler, Pumps, Valve bonnet, etc.

**Applied Fluids:** Steam, Lubricants, Hydrocarbon, Water, Hot water, Organic solvents, Cryogenic line, Oxygen gas, Low temperature gases, LPG, etc.

## STARFOIL® Tape Attached

- JIC 3840-□-(SF)** Double Jacketed Type (전피복형)  
**JIC 3841-□-(SF)** Double Shell Type (이중피복)  
**JIC 3860-□-(SF)** Double Jacketed Corrugated type (파형피복형)

\*□:NA, SF&CE available

#### [Characteristic]

Metal jacketed gasket with **STARFOIL®** tape 0.5mm thick on the sealing face. Excellent sealing performance with low bolt stress. Recommended for sealing gases.

실 표면에 0.5mm의 흑연테이프를 부착하여 제작한다. 유연한 흑연테이프는 낮은 볼트조임으로도 씰성을 유지할 수 있게 한다. 기체 씰용으로 추천된다.

#### [Application]

<b>Maximum Service Temp.</b>	530°C (Neutral or reducing atmosphere) 450°C (Oxidizing atmosphere)
<b>Short-term peak Pressure</b>	100kgf/cm <sup>2</sup>

Heat exchanger, High-pressure vessels, Boiler, Pumps, Valve bonnet, etc.

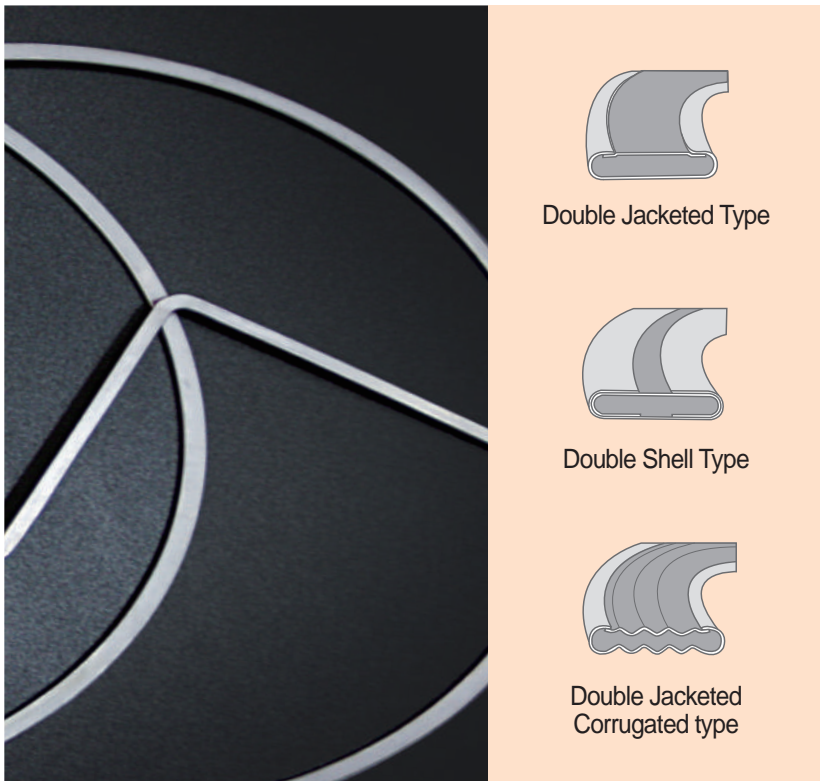

## Semi-Metallic Gaskets

### Kammprofile Gaskets

## Kammprofile Gaskets

Kammprofile Gasket is comprised of a concentrically serrated solid metal ring and various soft facing materials of soft facing such as flexible Graphite, PTFE, and Non-asbestos providing stable sealing performance.

The sealing layers protect flange surface damage from high bolt stress and excellent in recovery and compressibility. Especially, the metal core ensures the blowout resistance under operating condition.

Kammprofile Gasket은 일반적으로 Stainless 재질의 원판에 양쪽면으로 홈이 나있는 형상이다. 보통 양쪽 면에 Sealing층이 적용되며 사용영역에 따라 Flexible Graphite, PTFE, 비석면 재질 등이 사용된다.

Kammprofile Gasket은 밀봉성이 뛰어나 Sealing 층이 없어도 사용 가능하나 높은 체부력에 의해 플랜지 손상의 위험이 있으며 그 Sealing 층은 플랜지 표면을 손상으로 부터 보호하고 효과적인 밀봉성을 제공한다.

Soft Sealing Materials

Optional outer ring for centering can be integral or floating

Solid Metal core

Serrated surface machined on solid metal core

#### Solid metal core

Availability on low bolting stress in small contract area. Strong resistance in cold flow, over compression and breakage, High Stability of large size installation and handling

#### Soft sealing material

Supplement of uneven surface imperfections metal to metal during installation. Ideal for low stress and weak flange. Resistance in extreme temperature and pressure changes

### [ Kammprofile Gaskets Type ]

Name	Cross Section	Construction		Centering Ring		Flange			
		Parallel Root	Convex Root	Integral	Floating	Male / Female	Tongue / Groove	Flat Face	Raised Face
Parallel Type - Without Collar		●				●	●		
Parallel Type - With outer Collar		●		●				●	●
Parallel Type - With outer Ring (Floating Centering Ring)		●			●			●	●
Convex Type - With outer Ring (Floating Centering Ring)			●			●	●		
Convex Type - Without Collar			●	●				●	●
Convex Type - With outer Collar			●		●			●	●

## Semi-Metallic Gaskets

### Kammprofile Gaskets

<b>JIC 3850-SE</b>	Parallel Root (일체형)
<b>JIC 3850-SEB</b>	Floating Centering Ring (결합형)
<b>JIC 3850-SEC</b>	Convex Root (볼록형)

#### [Characteristic]

This Kammprofile gaskets provide a safe, effective seal with excellent flexibility and recovery, allowing seal integrity under the most severe operating conditions. Two part assembly, consisting of a precision serrated metallic core with the addition of flexible **STARFOIL**<sup>®</sup> Tapes bonded to each face of a solid metal core. While the solid metal core prevents gasket blowout, the facing **STARFOIL**<sup>®</sup> flows easily into the flange faces allowing a high integrity seal out of **STARFOIL**<sup>®</sup>'s characteristics, even under low applied seating stresses. Suitable for the application required a small bolt load since the contact area is very small and gasket seating pressures and temperature are very high. A full range of metallic core materials are available. JIC 3850-SE(SF) series. The soft facing material is **STARFITE**<sup>®</sup> tape which is preferred where extremely high temperature (max.1000°C) is required. 4 types of cross section as basic, with inner, with outer ring and with inner & outer ring are available in accordance with applied flanges.



— 금속판을 동심원상의 톱니형태(Serrated Type)로 제작하여 유효 접촉면적을 최소화하여 낮은 체부력에서도 장착 가능하게 한 가스켓. 적용 환경에 따라 Parallel Root Type과 Convex Type으로 Serration면의 형상이 달라지며, 필요 시 Inner Ring, Outer Ring을 부착하기도 함. Solid Metal Core를 직접으로 사용하기 곤란하거나, 보다 낮은 체부력을 필요로 하는 라인 또는 사용 조건에 따라 Serration 부위에 Soft Sealing Material을 부착하여 고온 환경, 내화학성이 요구되는 부분 등 다양한 용도로 활용 가능함. 적용 플랜지의 형상에 따라 기본형에 Inner Collar, Outer Collar를 부착하기도 함.

#### [Standard Facing Materials]

Facing Material	Temp. Max.	Range Stress at Room Temp. Min.	Maximum Service Pressure	Applied
<b>STARFOIL</b> <sup>®</sup> Tape JIC 3850-SE (SF)	450°C (840°F)	17 MPa (2500 psi)	Class 150 to 2500	<ul style="list-style-type: none"> <li>- Valve Bonnet and non-circular Flange, Heat Exchanger, Pressure Container</li> <li>- Depend on Temperature and liquid, Ring Material should be changeable.</li> </ul>
<b>STARFLON</b> <sup>®</sup> Tape JIC 3850-SE (TF)	260°C (500°F)	23 MPa (3300 psi)		
<b>STARFITE</b> <sup>®</sup> Tape JIC 3850-SE (HT)	1000°C (1830°F) Per Material	17 MPa (2500 psi) Per Material		

\* Maximum temp. & pressure combinations can not be used at the same time.

#### [Standard Core Materials]

Core Material	Temp. Max.
Stainless Steel	535-870°C (1000-1600°F)
Carbon Steel	425°C (800°F)
Brass	260°C (500°F)
Copper	315°C (600°F)
Aluminum	425°C (800°F)
Monel	815°C (1500°F)
Nickel	760°C (1400°F)
Inconel	1100°C (2000°F)

\* Standard core thickness is. 3.0mm (nominal); other thicknesses and materials are readily available to suit specific applications.

#### [Structure]

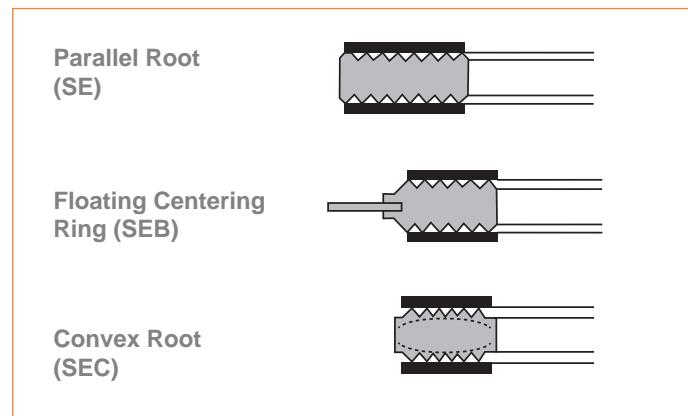



# Semi-Metallic Gaskets

## Spiral Wound Gasket Description

### [ Structure ]

#### 1. Spiral Wound Gasket Feature & Construction

The Spiral wound gasket is the ideal gasket in the semi-metallic category. The effects of pressure and temperature fluctuations, the temperature difference across the flange face, along with flange rotation, bolt stress relaxation and creep, demand a gasket with adequate flexibility and recovery, to maintain a seal under variable working conditions. The spiral wound gasket meets these requirements.

Widely used in the petrochemical, power plant, shipbuilding and oil refining industries where a cryogenic to high temperature and high pressure is required.

- Resistance to high temperature and high pressure.
- Superior resilience with allows the gasket to adjust automatically to change in operating conditions, like pressure and thermal shocks, vibrants, etc.
- Excellent sealing performance even on irregular flange surface finishes.
- Designed to diversified dimensions and shapes(round, oval, square, diamond, etc) with economical costs.
- Various hoop & filler materials available for specific operating conditions.

#### Spiral Wound Gasket 설명

Spiral Wound Gasket은 Semi-Metallic Gasket의 일종이며 Sealing성이 우수하고, 교환이 용이한 매우 이상적인 Gasket으로 발전소용, 정유공업용, 석유화학공업, 조선공업 등에 사용되어지며 재질에 따라 극저온에서 고온, 고압에 이르기까지 광범위하게 적용하고 있다.

박판의 금속재(Metal Winding)와 내약품성과 내열성이 뛰어난 충전재(Filler)가 단면이 "V" 형태로 나선형으로 감아 양끝을 융접하여 만든 Gasket로서 아래와 같은 우수한 기능을 가지고 있다.

- 고온, 고압에 사용가능
- 압력, 온도, 진동 등 운전조건 변화에 적응하는 능력이 우수
- 불균일한 플랜지면에서도 뛰어난 씰성
- 원형 또는 타원형 등 어떠한 치수라도 경제적인 가격으로 제작 가능
- 특수한 운전조건에 따라 Metal Winding 및 Filler의 재질을 선택하여 제작 가능

### 2. Structure

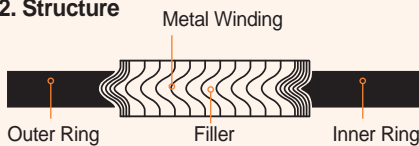

### 3. Metal Winding and Filler

- The unique structure of alternate plies of performed winding metal strip and a soft non-metallic filler materials with "V" shape allows superior resiliency and self-adjustment.
- The soft non-metallic fillers having good chemical resistance & heat resistance are necessarily flush with the metal winding on both contact faces of the gasket, thus producing a smooth sealing surface.

#### 금속박판과 충전재의 역할

- 박판의 Metal Winding(Hoop)과 Filler의 재질이 "V" 형태의 단면을 유지하여 구조상 압축이 되어 복원하려는 탄성을 가지고 있다.
- 내약품성과 내열성을 기본으로 하는 Filler재를 적용하여 상대방 플랜지면과 접촉하여 밀봉 (Sealing) 작용을 한다.

#### Note

- At winding formation in cross section, it's recommended to make filler somewhat protrudent over hoop that Filler parts(actual sealing ranges) to be touched on both flange faces. (the width of filler material > the width of winding strip)
- Heat resistance shall be selected by filler materials (STARFOIL®, STARFLON®, Non-asbestos, etc)

### [ How to Order Spiral Wound Gasket ]

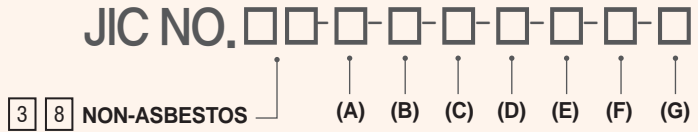

(A)	<b>Outer Ring</b>	(E)	<b>Inner Ring Material</b>
	0 No Outer Ring	(F)	<b>Outer Ring Material</b>
	3 With Outer Ring		None No Outer Ring
(B)	<b>Metal Winding</b>		SS Low Carbon Steel
	4 S.S 304		304 S.S 304
	6 S.S 316		As per table A Others
	8 Others	(G)	<b>Metal Winding</b>
(C)	<b>Inner Ring</b>		None S.S 304, 316
	None No Inner Ring		As per table A Others
	R With Inner Ring		SS Low Carbon Steel
			304 S.S 304
(D)	<b>Filler Material</b>		As per table A Others
	SF STARFOIL®		
	TF STARFLON®		
	NA NA Filler		
	NGLN NA+ STARFOIL® +NA		
	CGC CERAMIC+ STARFOIL®+ CERAMIC		
	HT STARPITE®		
	HTG STARPITE®+ STARFOIL®+ STARPITE®		

Table A .  
Material Code of Inner and Outer Ring

Material	Code	Material	Code
Low Carbon Steel	SS	S.S 321	321
S.S 304	304	S.S 430	430
S.S 316	316	Titanium	TI
S.S 316L	316L	S.S 304L	304L
S.S 347	347	MONEL	MO
NICKEL	NI	ALUMINIUM	AL
INCONEL 600	INC600	INCOLOY 800	IN800

EX) JIC-3834-R-SF-304-SS means Graphite with 304 winding and inner & outer ring type.  
=Winding(Hoop) SS304, Filler : STARFOIL®, Inner Ring : SS304, Outer Low carbon steel

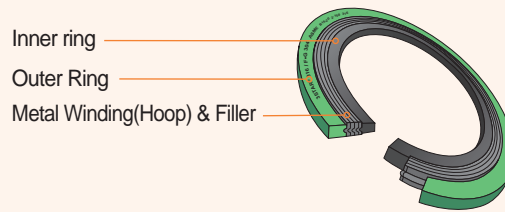

### 4. When recommend the use of Outer Ring

- To make Gasket centering with flanges.
- To protect Gasket Body
- To prevent over compression damage which might occur due to the high available bolt loading.

### 5. When recommend the use of Inner Ring

- Under high pressure & temperature in process fluids.
- To protect accumulation of solids, reduce turbulents flow of process fluids and minimize erosion of flange faces.
- When bigger size gasket required.
- When the use of STARFOIL®, STARFLON® filler materials. (to prevent over compression damage)

#### Note

- The Inner Ring materials should be used the same or the better grade out of winding metal materials.
- Inner rings are mandatory for the use at raised face, full face, male & female flanges to prevent damages to the gasket ore and inner windings especially, at the applications once inward buckling ever encountered.

## Semi-Metallic Gaskets

### Spiral Wound Gasket Description

#### [ How to Handle and use big sized Semi Metallic Gaskets ]

##### 1. Carrying

Specified workers required when carrying big size gasket to prevent deformation and it shall be moved in even interval for safety protection.

Diameter	1500mm Under	2000mm Under	2500mm Under	3000mm Under	3500mm Under	3500mm Over
Min. Worker	2	3	4	6	7	8

##### 2. Grid Method

###### a. Horizontally

Keeping your palm horizontal, place the gasket on the palms and then firmly but softly hold it with your thumbs.

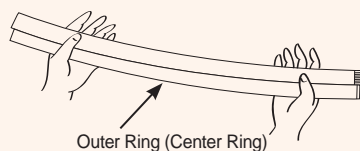

###### b. Vertically

keep your palms vertically and hold the gasket with thumbs and remaining firmly so as not to drop it.

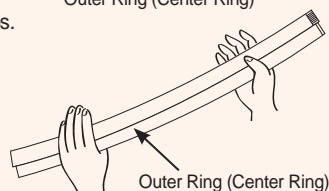

\* Treating : Gasket must not be thrown and fallen

##### 3. Storage and Precautions

- Please do not put any of heavy things on top of the gasket.
- Please do not storage in unstable and vibration conditions.
- Please avoid direct sunlight and keep in cool place, caring of humid and dust.
- Please observe first & first out process.
- Please pile up old gasket on top and using firstly, new one storages in bottom.

##### 대구경 가스켓 운반 방법

대구경 가스켓의 수평 이동 시에는 가스켓의 조립 이탈을 방지하기 위하여 적정 인원이 동일한 간격으로 위치하여 운반하여 주십시오.

##### 대구경 가스켓 운반 시 쥐는 방법

###### a. 수평 상태에서 쥐는 법

양손 바닥을 수평으로 해서 가스켓을 받치고, 엄지 손가락으로 가볍게 가스켓을 눌러 주십시오.

###### b. 수직 상태에서 쥐는 법

양손 바닥을 수직으로 하고, 가스켓은 떨어지지 않을 정도로 가볍게 엄지 손가락과 나머지 손가락으로 유지하여 주십시오.

##### 대구경 가스켓 보관 및 적재 시 주의 사항

- 대구경 가스켓의 상단에 중량물을 올리지 마십시오.
- 바닥이 불균일하거나 진동이 많은 장소에 가스켓을 적재하지 마십시오.
- 직사광선을 피하고 습기와 먼지가 없는 서늘한 장소에 보관 하십시오.
- 선입 선출 : 새로 들어온 것은 아랫쪽에 적재를 하고, 오래된 것은 위쪽에 적재를 하여 오래된 것을 먼저 사용하도록 하십시오.

#### [ Spiral Wound Gasket Marking ]

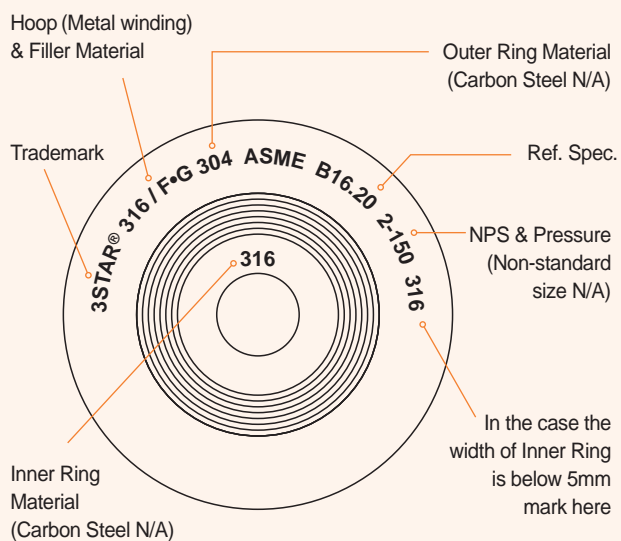

#### [ Recommended Compressed Thickness(RCT) ]

Gasket Thickness	RCT
3.2	2.4 ~ 2.6
4.5	3.2 ~ 3.4
6.4	4.6 ~ 4.8

#### [ Recommended Gasket Thickness ]

Gasket Thickness	Flange Diameter
4.5mm	~ Ø 1000
6.4mm	Ø 1000 ~

#### [ Recommended Design Parameters ]

Item	Gasket Factor M	Min. Design Seating Stress Y (psi / MPa)	Sketches
Winding Material			
Carbon Steel	2.50	10,000 / 69	
Stainless and Nickel-base alloys	3.00	10,000 / 69	

## Semi-Metallic Gaskets

### Application for Flanges (Spiral Wound Gasket)

#### [ Cross Section as Flanges ]

Type	Cross Section	Flanges	Remarks
Basic		Tongue & Groove, Male & Female	At <b>STARFOIL®</b> , <b>STARFLON®</b> Filler, inner ring type should be recommended.
With Inner Ring Type		Male & Female	
With Outer Ring Type		Raised Face & Flat Face	At <b>STARFOIL®</b> , <b>STARFLON®</b> Filler, inner ring type should be recommended.
With Inner & Outer Type		Raised Face & Flat Face	

#### [ Recommended Gasket Style ]

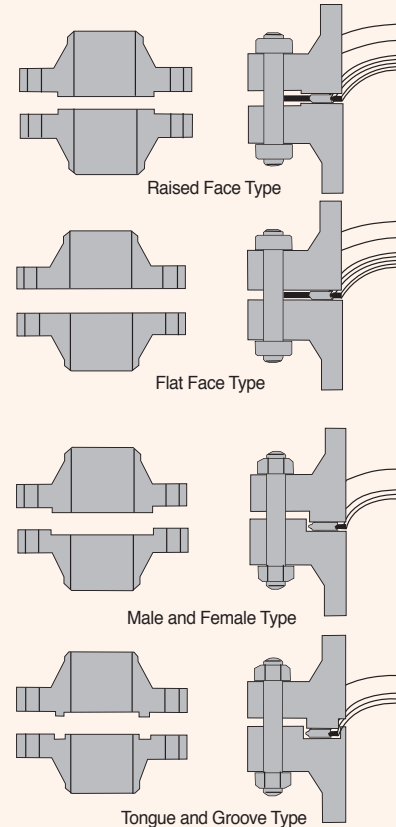

#### [ Tolerance of Dimensions ]

[Unit : mm]

Normal Pipe Size (NPS)	Inner Ring I.D (D <sup>1</sup> )	Gasket I.D (D <sup>2</sup> )	Gasket O.D (D <sup>3</sup> )	Outer Ring (D <sup>4</sup> )	Gasket Thickness T <sup>(1)</sup>
1/2" ~ 3"	±0.8	±0.4	±0.8		±0.13
4" ~ 8"	±1.5	±0.8	+1.5, -0.8	±0.8	
10" ~ 24"					
26" ~ 34"	±3.0	±1.5			
36" ~ 60"					

#### Note

(1) The gasket thickness is ±0.13mm, measured across the metallic portion of the gasket not including the filler, which may protrude slightly beyond the metal

#### [ Cross Section and JIC No. ]

Cross Section	Metal Winding	Filler Material			Application	Standard
		Non-Asbestos	STARFOIL® (Graphite)	STARFLON® (PTFE)		
 Gasket Thickness : 4.5mm <b>Basic type</b> (Without anything attached)	Stainless Steel 304	3804-NA	3804-SF	3804-TF	High Temperature & Pressure Equipment, Extreme Low Temperature Equipment, Valve, Boiler Manhole, Handhole, Turbine, Pump Casting Cover T&G, M&F Flange Special Flange	KS B1518 JIS B2404 JPI 7S-41
	Stainless Steel 316	3806-NA	3806-SF	3806-TF		
	As specified	3808-NA	3808-SF	3808-TF		
 <b>Inner Ring :</b> Low Carbon Steel 3.0mm Stainless Steel 3.0mm Gasket Thickness : 4.5mm	Stainless Steel 304	3804-R-NA	3804-R-SF	3804-R-TF	High Temperature & Pressure Equipment, Extreme Low Temperature Equipment, T&G, M&F Flange	KS B1518 JIS B2404 JPI 7S-41
	Stainless Steel 316	3806-R-NA	3806-R-SF	3806-R-TF		
	As specified	3808-R-NA	3808-R-SF	3808-R-TF		
 <b>Outer Ring :</b> Low Carbon Steel 3.0mm Stainless Steel 3.0mm Gasket Thickness : 4.5mm With outer guide ring attached	Stainless Steel 304	3834-NA	3834-SF	3834-TF	High Temperature & Pressure Equipment, Extreme Low Temperature Pipe, General Pipe Flange, R.F. Flange, Flat Flange	KS B1518 JIS B 2404 JPI-7S-41 ASME B16.20
	Stainless Steel 316	3836-NA	3836-SF	3836-TF		
	As specified	3838-NA	3838-SF	3838-TF		
 <b>Inner &amp; Outer Ring :</b> Low Carbon Steel 3.0mm Stainless Steel 3.0mm Gasket Thickness : 4.5mm With outer guide ring and inner ring attached	Stainless Steel 304	3834-R-NA	3834-R-SF	3834-R-TF	Places requiring Merits of Outer and Inner Rings. RF Flange, Flat Flange	KS B1518 JIS B 2404 JPI-7S-41 ASME B16.20
	Stainless Steel 316	3836-R-NA	3836-R-SF	3836-R-TF		
	As specified	3838-R-NA	3838-R-SF	3838-R-TF		



## Semi-Metallic Gaskets

### Maximum Bore of ASME B16.5 Flanges for use with Spiral Wound Gaskets

Flanges Size (NPS)	Pressure Class							
	75	150	300	400	600	900(1)	1500(1)	2500(1)
1/2	No Flange	W/N Flange only (2)	No Flanges Use Class 600	W/N Flange only (2)	No Flanges Use Class 1500	W/N Flange only (2)	W/N Flange only (2)	W/N Flange only (2)
3/4								
1								
1 1/4		SO Flange (3) W/N Flange (2)	SO Flange (3) W/N Flange (2)	SO Flange (3) W/N Flange (2)	SO Flange (3) W/N Flange, any bore	W/N Flange with SW bore(Includes nozzle(4) but excludes SO Flange)	W/N Flange with SW bore(Includes nozzle(4) but excludes SO Flange)	
1 1/2								
2		SO Flange (3) W/N Flange, any bore	SO Flange (3) W/N Flange, any bore	SO Flange (3) W/N Flange, any bore	SO Flange (3) W/N Flange, any bore	W/N Flange with Schedule 80 bore (excludes nozzle (4) and SO Flange)(5)	W/N Flange with Schedule 80 bore (excludes nozzle (4) and SO Flange)(5)	
2 1/2								
3		SO Flange W/N Flange, any bore	W/N Flange with Schedule 10S bore described in ASME B36.19M(Includes nozzle(4) but excludes SO Flange)	W/N Flange with Schedule 10S bore described in ASME B36.19M(Includes nozzle(4) and excludes SO Flange)(5)	W/N Flange with Schedule 10S bore described in ASME B36.19M(Includes nozzle(4) and excludes SO Flange)(5)	W/N Flange with Schedule 80 bore (excludes nozzle (4) and SO Flange)(5)	W/N Flange with Schedule 80 bore (excludes nozzle (4) and SO Flange)(5)	No Flanges
4								
6								
8								
10								
12								
14								
16								
18								
20								
24								

**General Note**

(a) This table shows the maximum bore of flange for which the spiral wound gasket dimensions shown in Table 9(ASME B16.20:2007) are recommended, considering the tolerances involved, possible eccentric installation, and the possibility that the gasket may extend into the assembled flange bore.

(b) For maximum permissible flange bores for nonmandatory inner rings.

(c) Abbreviations: So = slip on and threaded, W/N = welding neck, and SW = standard wall.

**Note**

(1) Refer to para. 3.2.5(ASME B16.20:2007) for required use of inner rings. These inner rings may extend into the pipe bore a maximum of 1.5mm under the worst combination of maximum bore, eccentric installation, and additive tolerances.

(2) In these sizes, the gasket is suitable for a welding neck flange with a standard wall bore, if the gasket and the flanges are assembled concentrically. This also applies to a nozzle. It is the user's responsibility to determine if the gasket is satisfactory for a flange of any larger bore.

(3) Gaskets in these sizes are suitable for slip-on flanges only if the gaskets and flanges are assembled concentrically.

(4) A nozzle is a long welding neck; the bore equals the flange NPS.

(5) An NPS 24 gasket is suitable for nozzles.

### [ Effective Gasket Width<sup>2</sup>(Cont'd) ]

Facing Sketch	Basic Gasket Seating Width $b_0$	
	Column I	Column II
(1a)	$\frac{N}{2}$	$\frac{N}{2}$
(1b)		
(1c)	$\frac{W+T}{2}; \left(\frac{W+N}{2} \max\right)$	$\frac{W+T}{2}; \left(\frac{W+N}{4} \max\right)$
(1d)		
See Note(1)	$\frac{W+N}{4}$	$\frac{W+3N}{8}$
(2) 1/64 in.(0.4mm) nubbin		
(3) 1/64 in.(0.4mm) nubbin	$\frac{N}{4}$	$\frac{3N}{8}$
(4) See Note(1)	$\frac{3N}{8}$	$\frac{7N}{16}$
(5) See Note(1)	$\frac{N}{4}$	$\frac{3N}{8}$
(6)	$\frac{N}{8}$	-

Effective Gasket Seating Width,  $b$   
 $b=b_{01}$  When  $b_0 \geq \frac{1}{4}$  in.(6mm);  $b=C_b \sqrt{b_{01}}$  When  $b_0 < \frac{1}{4}$  in.(6mm)

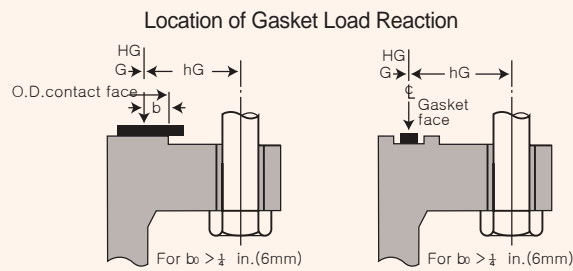

**Note**

(1) Where serrations do not exceed 1/64 in.(0.4mm) depth and 1/32 in.(0.8mm) width spacing, sketches (1b) and (1d) shall be used.

(2) The gasket factors listed only apply to flanged joints in which the gasket is contained entirely within the inner edges of the bolt holes.

## Semi-Metallic Gaskets

### Standard Type of Metal Jacketed Gaskets

#### [ Availability of Jacket Materials ]

A Wide range of gasket material is available to company with specific operating conditions. Jeil's extensive material inventories are as introduced below

Metal of Jacket (Vickers, Max)	Low Carbon Steel	Copper	SS 304	SS 304L	SS 316	SS 316L	SS 317L	SS 321	SS 347	SS 310S	SS 410	Bronze	Al-Bronze	Monel	Titanium	Nickel	Aluminium	Lead
Max Hardness Vickers(HV)	140	80	180	170	180	170	170	180	180	180	190	130	150	150	180	150	40	10
Max OD (Outer Diameter,mm)	1200	980	1200	1200	1200	1200	980	1200	1200	1080	980	980	980	880	980	880	980	1500

Filler : NA Millboard / **STARFOIL**<sup>®</sup> Sheet (Graphite) / **STARFLON**<sup>®</sup> Sheet(PTFE) / Ceramic Board

Additional Attachment : **STARFOIL**<sup>®</sup> (Expended Graphite Tape)

#### [ Design data for Metal Jacketed Gasket ]

Jacket Material	Soft Aluminum	Soft Copper or Brass	Iron or Soft Steel	Monel	4%~6% Chrome	Stainless and Nickel - Base Alloys
<b>Gasket Factor M</b>	3.25	3.50	3.75	3.50	3.75	3.75
<b>Min. Design Seating Stress Y (MPa/psi)</b>	38 / 5,500	45 / 6,500	52 / 7,600	55 / 8,000	62 / 9,000	62 / 9,000

Sketches



#### [ Cross Section and JIC NO. ]

Type	Cross Section	Filler Material			
		Non-asbestos	<b>STARFOIL</b> <sup>®</sup>	<b>STARFLON</b> <sup>®</sup>	Ceramic
Double Jacketed Gasket		3840-NA	3840-SF	-	3840-CE
Double Jacketed & Double Shell Gasket		3841-NA	3841-SF	3841-TF	3841-CE
Double Jacketed Corrugated Gasket		3860-NA	3860-SF	-	3860-CE
French Type Gasket		3842-NA	3842-SF	3842-TF	3842-CE
Round Jacketed Gasket		3843-NA	3843-SF	3843-TF	3843-CE
Double Jacketed Gasket with <b>STARFOIL</b> <sup>®</sup> Tape		3840-NA(SF)	3840-SF(SF)	-	3840-CE(SF)
		3841-NA(SF)	3841-SF(SF)	3841-TF(SF)	3841-CE(SF)

## Semi-Metallic Gaskets

### Standard Type of Metal Jacketed Gaskets

[ How to Order Metal Jacketed Gasket ]

JIC NO. □□□-□□-□□-□□

3 | 8 | Metal(Jacket) Gasket (A) (B) (C) (D) (E) (F)

(A)	<b>Cross Section</b>		(E)	<b>Material of Jacket Metal</b>	
	4	Flat Type		D	Soft Iron
	6	Corrugated Type	S	Low Carbon Steel	
(B)	<b>Jacket Type</b>		CU	Copper	
	0	Double Jacketed	AL	Aluminium	
	1	Double Jacketed Double Shell	304	SUS 304	
	2	French Type	304L	SUS 304L	
	3	Round Type	316	SUS 316	
(C)	<b>Filler Material</b>		316L	SUS 316L	
	NA	NA Filler	321	SUS 321	
	SF	STARFOIL® (Graphite)	410S	SUS 410S	
	TF	STARFLON® (PTFE)	MO	Monel	
	CE	Ceramic	BS	Brass	
(D)	*With STARFOIL® Tape: (SF)		PB	Lead	
			NI	Nickel	
			TI	Titanium	
			<b>(F) Gasket Shape : A-Z</b>		

EX. JIC NO. 3840-TF-(SF)-S-Z Double Jacketed Gasket with STARFOIL® Tape Cross Section  
: Flat Jacket Type / Double Jacket Filler : STARFLON®(PTFE) / Metal : Low Carbon Steel / Shape : Z

#### [ Dimensional Data ]

##### •Double Jacketed Gasket

[Unit : mm]

Standard Thickness	3.0 or 1/8"
R	8 min
W	7 min
I	2.0 ~ 3.0
L	2.5 min
a	2.0 min
Metal Thickness	0.3 ~ 0.5

#### [ Double Jacket Gasket ]

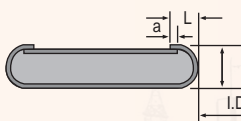
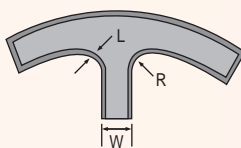

##### •Double Jacket Corrugated Gasket

[Unit : mm]

T (Gasket Thickness)	3.0 min
W (Gasket Width)	15.0 min
t (Corrugation Height)	1.0±0.3
P(Corrugation Pitch)	6.4
Metal Thickness	0.3 ~ 0.5

#### [ Double Jacket Corrugated Gasket ]

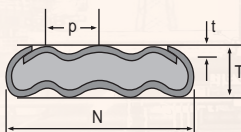

##### •Tolerance

[Unit : mm]

<b>Dimensions</b>	<b>Tolerance</b>
Up to 250mm ID, OD	± 0.5
251~500mm ID, OD	± 1.0
501~1000mm ID, OD	± 1.5
1001mm ~ ID, OD	± 2.0
Metal Thickness	± 0.2



## Semi-Metallic Gaskets

### Standard Shapes for Heat Exchanger Gaskets

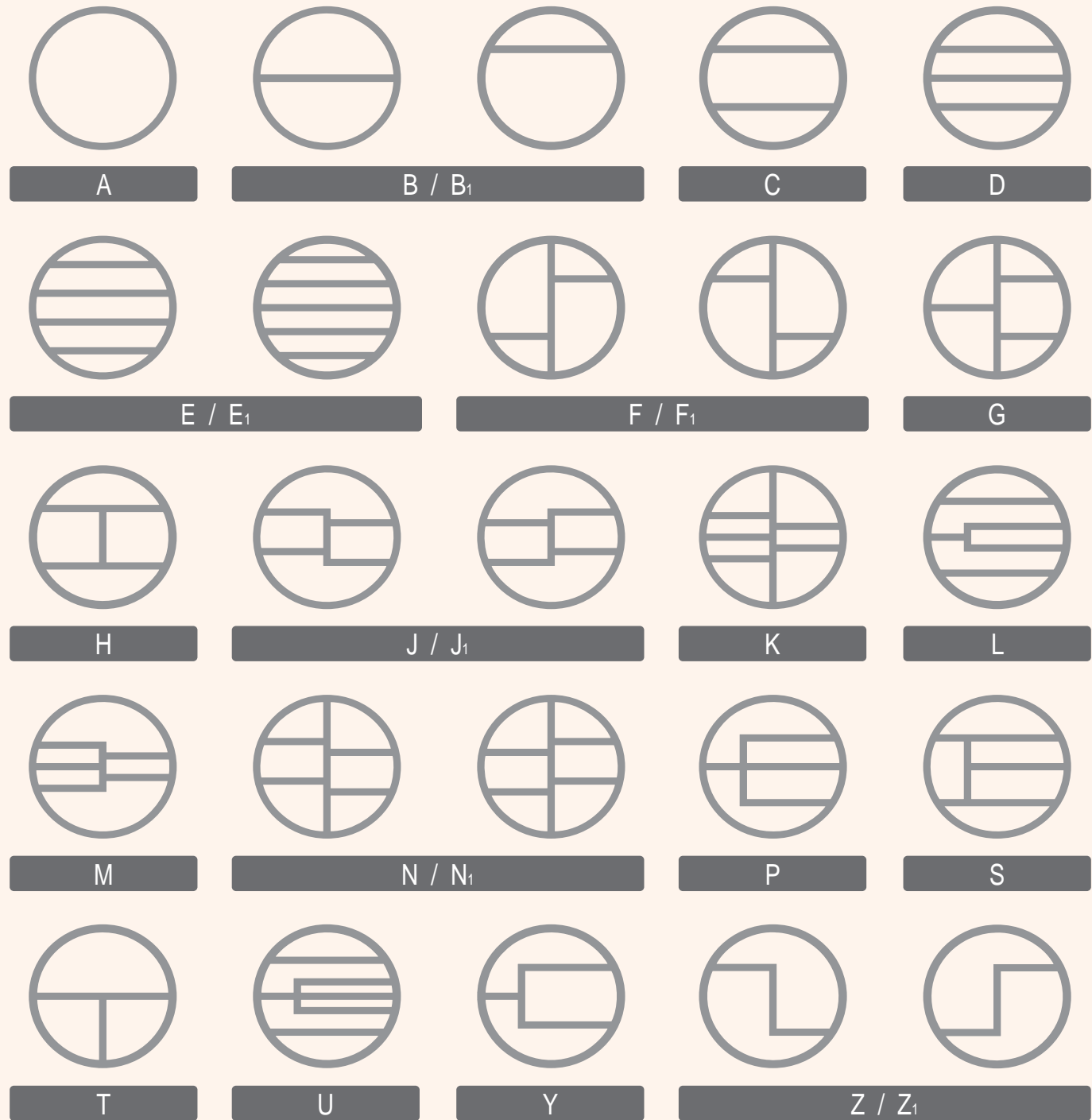

\* All shape sketched above are seen from the side A. (↕)

상기 형상은  상태의 스케치입니다.



# Metal Gaskets

Ring Joint Gaskets / Other Metal Gaskets

## JIC 3850



### [Characteristic]

This ring joint gasket designed for use in high pressure, temperature applications necessitated the need for a high integrity seal. They are mainly used in the high pressure vessel, pipe flanges, valve bonnets handling high pressure steam, gas, hot oil, oil gas, solvent vapor industries, etc.

A wide range of sizes and materials are available on request. The hardness of the ring should always be less than the hardness of the flanges.

링 조인트 가스켓은 관플랜지, 압력용기, 고압증기를 취급하는 밸브 본네트, 기체, 열유, 유류가스, 고온의 용제 증기 등에 사용되는 내압 가스켓.

### 3850-V (Ring joint Oval Type)

This type is the original Joint design. Contacts flange face at the curved surface and provides a high reliability seal. But due to its shape, it is harder to achieve accuracy of dimensions and surface finish in oval type than in octagonal one and also more expensive to make. Reduce is not possible. Complies with ASME B16, 20, API 6A, JIS F 7102 510SR, JPI-7S-23.

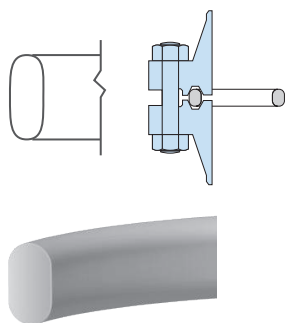

### 3850-C (Ring joint Octagonal Type)

More economical to make and more accurate in dimensions and surface finish than oval type because it consists of straight surfaces only. But more torque load is required to flow the gasket material into imperfections on the flange facings. Reuse is possible. Complies with the same standards as above.

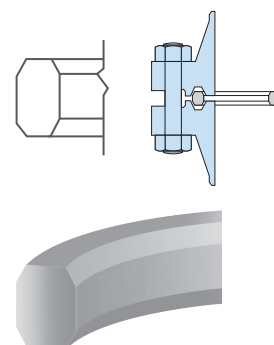

### 3850-BX (Ring joint BX Type)

Designed to API 6A for use with grooved flanges on special applications involving high pressures from 5,000 to 15,000 psi

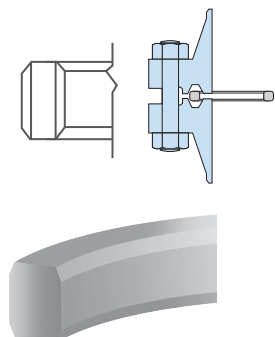

### 3850-RX (Ring joint RX Type)



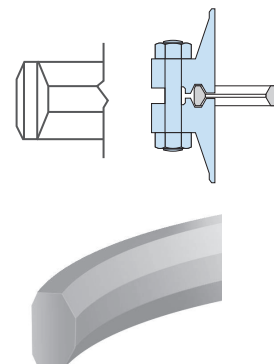







Designed to API 6A. Interchangeable with the oval and octagonal series of identical reference numbers, and used in the same flange grooves.



## Metal Gaskets

### Ring Joint Gaskets / Other Metal Gaskets

#### Cross Section and JIC No.

	<b>3850-P</b> (Plain)	Flat ring punched or lathed from comparatively soft metal such as aluminum, copper etc. Relatively inexpensive to make.
	<b>3850-L</b> (Lens Ring)	Designed to DIN 2696. Bolt load will be comparatively small, because its contact surface with flange face is spherical.
	<b>3850-DC</b> (Double Cone)	Auto seal type gasket. For effective sealability, aluminum sheets of 1.5~2.0mm are used together. Used for pressure vessel.
	<b>3850-B</b> (Bridgeman)	Auto seal type gasket. It is called a seal ring when this gasket is used for valve. Used for valve bonnet, pressure vessel, heat exchanger.
	<b>3850-D</b> (Delta)	Auto seal type gasket. For effective sealability, silver is plated on surface. Used for pressure vessel.
	<b>3850-SE</b> (Serrated)	Flat ring with concentric serrations made of various types of metal, Used when bolting force is not sufficient to seal a flat gasket because it contacts flange face only at serration peaks, commonly used on valve bonnets and flanges attached to equipment. 3 types of cross section- basic, with outer ring and with inner & outer ring-are available.
	<b>3850-WR</b> (H)	The use of welded gasket with hollow lip type "H" is recommended for connecting constructional part with different thermal expansion coefficients. This Welded Ring type "H" gasket have the advantage of increased ability to absorb movement. For example, this type "H" is preferably installed to seal heat exchanger bonnet Flanges and tube plate, Where different radial movement occurs.
	<b>3850-WR</b> (HR)	"HR" type gaskets supplied with a female face and Grooved Gasket inserted, so that if there is any damage to the gasket it can be replaced. The advantage of the welded ring gasket lies in its great ability to absorb movement. It is mainly used on heat exchangers to cope with different radial expansions, for instance of bonnet flange and tube plate.
	<b>3850-WR</b> (B)	Type "B" Gaskets are predominantly used in pipeline construction, where the twin flange design means that no large differences in strain properties arise when the same material for the gasket and flange is selected.
	<b>3850-COR</b> (SF)	This graphite laminate is produced by bonding two flexible graphite sheets either to each other or to a central metal inset. Since only very small quantities of adhesive-thickness below 20mm are used, the outstanding chemical resistance of flexible graphite remains unaffected.

## JIC 3800 Metal O-Ring

### [Characteristic]

Metal O-Ring shape gasket made of stainless steel (SUS 321) or Inconel (IN-600) tube, Bent metal tube is welded and finished very precisely. For sealing of gases and volatile fluids, vacuum service, PTFE coated type or silver plated type are recommended. 2 types are available as follows.

Metal O-Ring SUS 321 혹은 Inconel 600 tube로 제작한 형태의 가스켓이다. 치수에 맞게 구부린 튜브를 정밀하게 용접 제작한다. 가스회발성액체 및 진공의 Seal을 위하여 불소수지코팅 혹은 은도금 타입이 추천된다. 아래와 같이 2가지 타입이 가능.

### [Type and Recommendation]

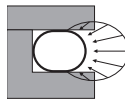
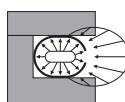
	<b>3800-P</b>	<b>Standard type :</b> From vacuum to 70kgf/cm <sup>2</sup>
	<b>3800-V</b>	<b>With small vent holes type :</b> Small vent holes of 2 and over are made either ID or OD side of gasket. <b>Self sealing type :</b> For high pressure seal over 70kgf/cm <sup>2</sup>

### [Service Range]

<b>Maximum Pressure Range</b>	up to 4000kgf/cm <sup>2</sup> for water up to 3000kgf/cm <sup>2</sup> for gases up to 10 <sup>6</sup> mm Hg for vacuum service
Lubricating oil, Hydraulic fluid, Fuel, Molten plastic, Molten rubber, Steam, Hot water	

### [Standard Material and Service Temperature]

Material	Code	Coating	Service Temp.(°C)	Remarks
SUS 321	321	None	-250 ~ 300	Coating Thickness : 0.03~0.05mm Plating Thickness : 0.03~0.05mm
		PTFE	-250 ~ 250	
		Silver	~ 300	
Inconel 600	IN	None	~ 500	Coating Thickness : 0.03~0.05mm Plating Thickness : 0.03~0.05mm
		PTFE	~ 250	
		Silver	~ 500	

### [Standard Dimensions]

[Unit : mm]

Tube Diameter	Standard Wall Thickness	Available Size(O.D)	Recommended Size	Compression Load(1)
0.8	0.15	6~30	6~25	60kgf/cm
1.6	0.36	13~200	15~50	200~250
2.4	0.48	40~500	40~200	200~250
3.2	0.50	50~1500	65~700	150~250
4.8	0.80	150~1500	500~1200	300~350
6.4	0.80	250~1500	1000~1500	150~200

(1) For SUS 321



# Metal Gaskets

## Information

### [ How to Order JIC Metal Gasket ]

JIC NO.3850-- Cross Sectional Shape : such as "C", "V", "P", etc. (see 44 page)  
Material Code : such as "S", "304", etc.

### [ Metallic Codes for Metal Gaskets ]

Material	Ident. Code	Hardness		UNS Code
		Brinell	Rockwell Scale "B"	
Soft Iron	D	90	56	-
Low Carbon Steel	S	120	68	-
Copper	CU	60	-	-
SS 304	304	160	83	S30400
SS 304L	304L	150	81	S30403
SS 316	316	160	83	S31600
SS 316L	316L	150	81	S31603
SS 321	321	160	83	S32100
SS 347	347	160	83	S34700
SS 410	410	170	87	S41000
SS 430	430	170	87	S43000
5cr-0.5Mo	F5	130	72	K42544
Monel400	M	140	77	N04400
Titanium	TI	160	83	-
Aluminium	AL	40	-	-
Nickel200	NI	120	67	N02200

*Note*  
 1. Not applied for JIC3850-P press-cut from sheet.

### [ Standard Sizes (ASME B16.20-2007) ]

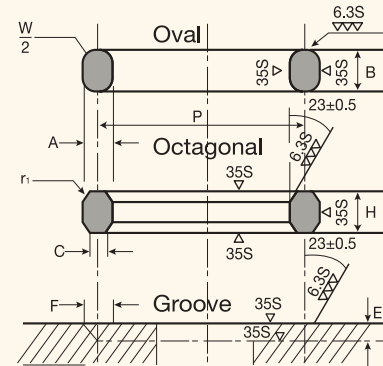

$r_1$  : 1.59mm when  $W$  is 22.225mm and smaller  
 2.38mm when  $W$  is 25.400mm and larger

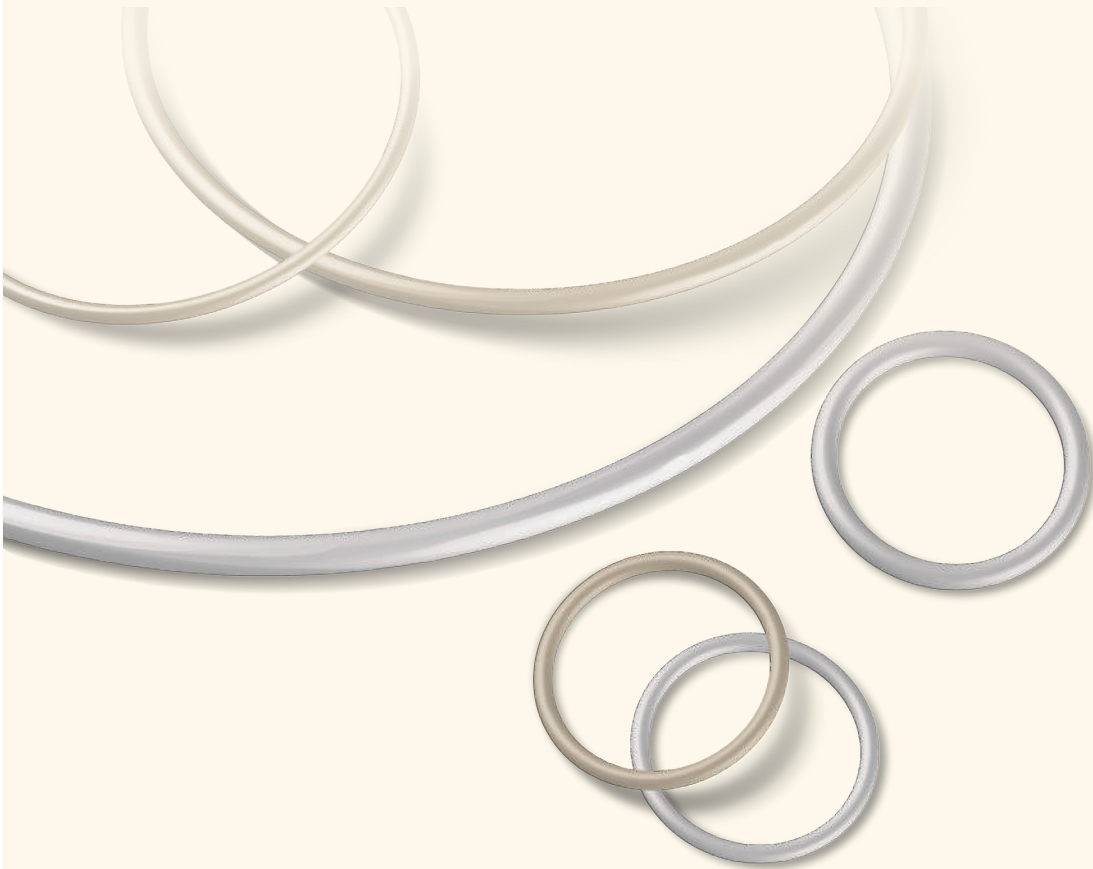

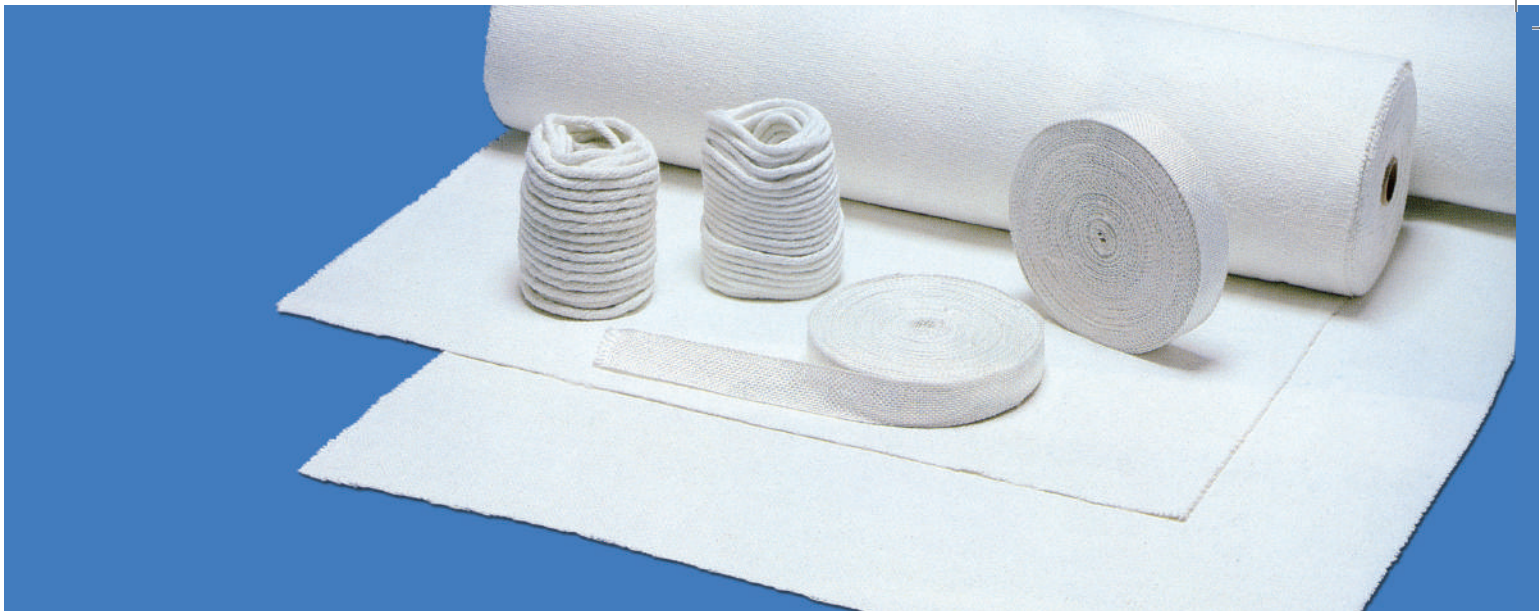

# Insulation Textiles

## JIC 7000 | Glass Fiber Cloth 유리 섬유포

**Characteristic :** E Glass or bulky glass yarns are woven into a cloth.  
E Glass Yarn을 이용하여 제작한 유리 섬유포.

**Application :** Used as heat insulating or Flame resistant curtain.  
Especially JIC 7000 is suitable for asbestos substitute cloth due to flexibility, good resin impregnation and heat insulation.

Max Service Temp. (°C)	550
Width (mm)	1000
Thickness (mm)	1.5 / 3.0
Length (M)	30

## JIC 7200 | Glass Fiber Tape 유리 섬유 테이프

**Characteristic :** E Glass Yarns are bulky-processed and woven into a tape.  
E Glass Yarn을 이용하여 제작한 유리 섬유 테이프.

**Application :** Heat insulation, Flame protector

Max Service Temp. (°C)	550
Width (mm)	25-100
Thickness (mm)	1.5 / 3.0
Length (M)	30

## JIC 7300 | Ceramic Fiber Cloth 세라믹 섬유포

**Characteristic :** Ceramic yarns are woven into a cloth.  
Ceramic Yarn을 이용하여 제작한 세라믹 섬유포.

**Application :** Heat insulation, Flame protector

Max Service Temp. (°C)	1300
Width (mm)	1000
Thickness (mm)	1.5 / 3.0
Length (M)	30

## JIC 7400 | Ceramic Fiber Tape 세라믹 섬유 테이프

**Characteristic :** Ceramic yarns are woven into a tape.  
Ceramic Yarn을 이용하여 제작한 세라믹 섬유 테이프.

**Application :** Heat insulation, Flame protector

Max Service Temp. (°C)	1300
Width (mm)	25-100
Thickness (mm)	1.5 / 3.0
Length (M)	30

## JIC 7500 | Silica Fiber Cloth 실리카 섬유포

**Characteristic :** Silica yarns are woven into a cloth.  
Silica Yarn을 이용하여 제작한 실리카 섬유포.

**Application :** Heat insulation, Flame protector, Flame resistant curtain

Max Service Temp. (°C)	1000
Width (mm)	1000
Thickness (mm)	1.5 / 3.0
Length (M)	30

## JIC 7600 | Silica Fiber Tape 실리카 섬유 테이프

**Characteristic :** Silica yarns are woven into a tape.  
Silica Yarn을 이용하여 제작한 실리카 섬유 테이프.

**Application :** Heat insulation, Flame protector

Max Service Temp. (°C)	1000
Width (mm)	25-100
Thickness (mm)	1.5 / 3.0
Length (M)	30



# Gland Packing

## Expanded Graphite Packing

### JIC 3020

#### Expanded Graphite Packing

팽창 흑연 패킹

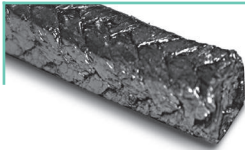

Expanded Graphite Yarns are braided into a square type of packing with high flexibility, elasticity and anti-abrasiveness to shaft or sleeve of high temperature/pressure valve or pump. Suitable for chemical plants, water, steam, gases, solvents, etc.

Expanded Graphite Yarn을 사용하여 단면 각형으로 편조한 패킹. 유연성 및 신축성을 가지고 있으며, 특히 자기윤활성 및 열방산성이 우수하기 때문에 고온, 고압용의 밸브 및 펌프류에 사용할 때 Shaft 및 Sleeve의 마모가 발생하지 않는 패킹.



pH	0~14
Service Temp. Range (°C)	-200 ~ 600°C
Max. Pressure	200kgf/cm <sup>2</sup>

### JIC 3020-I

#### Inconel Wire Inserted Expanded Graphite Packing

인코넬선입 팽창 흑연 패킹

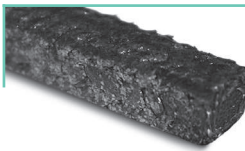

Inconel wire inserted expanded Graphite yarns are braided into a square type of packing with flexibility. It shows superior heat resistant and thermal conductivity. Excellent thermal scattering and long life by self-lubricating. Suitable for high temperature/pressure valves, etc.

Expanded Graphite Yarn을 인코넬선으로 보강하여 단면 각형으로 편조한 패킹. 내열도가 우수하고, 열전도성이 양호하며, 마찰열에 대한 열방산성이 뛰어나므로 고온, 고압의 밸브류에 적합한 패킹이다. 주로 JIC 4101과 병합하여 사용.



pH	0~14
Service Temp. Range (°C)	-200 ~ 600°C
Max. Pressure	260kgf/cm <sup>2</sup>





## PTFE Fiber Packing

### JIC 3063

PTFE Fiber Packing 테프론 섬유 패킹



Pure PTFE fiber yarns are braided into a packing in square or lattice-section type. Excellent heat resistant and chemical resistant, but suitable for places where contamination of fluids must be avoided because of excellent resistance against chemicals and corrosion. Outer cooling device is required when heated packing is likely to stick to shaft in operation due to nature of PTFE. Suitable for fusing alkali, metal, acid except hot fluoric acid, alkaline solvents, rotary machine, reciprocating machine, valve, etc.

PTFE 섬유를 8편 또는 격자편으로 편조한 패킹. 내약품, 내식성 등이 극히 우수. 패킹에 의한 유체 오염을 피하는 용도에 적합. PTFE는 저마찰성이지만 열팽창율이 높고, 열전도율이 낮아 마찰면의 발열이 커 열부착의 위험성이 있을 때는 외부냉각이 필요. 용융알카리 금속, 고온불소를 제외한 전 산, 알카리, 용제, 회전기기, 왕복동기기, 밸브 등에 사용.



pH	0~14
Max. Temp.(°C)	260 (500°F)
Max. Pressure	100kgf/cm <sup>2</sup>

### JIC 3064

Lubricated PTFE Fiber Packing 윤활유입 테프론 패킹



Same as JIC 3063 but impregnated with PTFE dispersion and special lubricant. Mechanically strong, anti-corrosive and suitable for variety of machinery. Suitable for corrosive fluid, hydrochloric acid, acetic acid, lactic acid, chemicals, strong alkali, rotary pump, reciprocating machine, rotary machine, etc.

JIC 3063 PTFE 섬유 편조 패킹에 PTFE Dispersion 및 특수윤활유를 함침시킨 패킹, 가장 내식성이 우수한 패킹으로서, 거의 전 약품에 사용되며 기계적 강도가 강 인하며 내마모성도 우수. 부식성 유체, 염산, 초산, 유산, 각종 화학 약품, 강알카리, 회전펌프, 왕복동기기, 회전기기 등에 사용.



pH	0~14
Max. Temp.(°C)	260 (500°F)
Max. Pressure	20kgf/cm <sup>2</sup>
Shaft speed	V-10m/s

## PTFE Fiber and Aramid Fiber Packing

### JIC 3065

Lubricated PTFE Fiber and Aramid Fiber Packing

윤활유입 테프론 섬유 및 아라미드 섬유 혼합 패킹

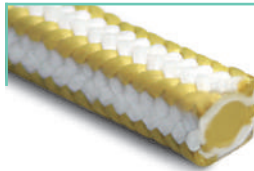

Lubricated PTFE fiber yarns and aramid fiber yarns are braided in combination. Excellent chemical resistant and mechanically strong packing. Suitable for strong acid, strong alkali, chemicals, solvents, rotary pumps, reciprocating machine, chemical pumps, rotary machine, etc.

PTFE Dispersion 및 특수윤활제를 함침시킨 테프론 섬유와 PTFE Dispersion 및 내열성윤활유를 함침시킨 아라미드 섬유를 혼합편조한 패킹. 내약품성 및 기계적 강도가 뛰어나며 특히 내마모성이 우수. 강산, 강알카리 용액, 각종 화학약품 및 용제, 회전 펌프, 왕복동기기, 화학펌프, 회전기기 등에 사용.



pH	0~14
Max. Temp.(°C)	260 (500°F)
Max. Pressure	20kgf/cm <sup>2</sup>
Shaft speed	V-16m/s

## PTFE Fiber and Graphite / PTFE Fiber Packing

### JIC 3067

Lubricated PTFE Fiber and Graphite Fiber Packing

윤활유입 테프론 섬유 및 Graphite 섬유 혼합 패킹

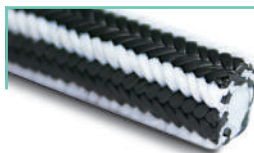

PTFE/Graphite fiber yarns and lubricated PTFE yarns are braided to a packing in combination. It shows excellent chemical resistance, mechanic strength and self-lubricating. Suitable for corrosive fluid, organic solvents, chemicals rotary machine, rotary pumps, reciprocating pumps, agitator, etc.

테프론에 흑연 미립자를 분산시켜 만든 첨단 섬유와 PTFE 섬유에 특수윤활제를 함침시킨 섬유로 편조한 패킹. 내약품성 및 기계적 강도가 뛰어나며, 자기 윤활성이 우수. 부식성 유체, 유기용제, 각종 화학약품, 회전기기, 회전펌프, 왕복동 펌프, 교반기 등에 사용.



pH	0~14
Max. Temp.(°C)	260 (500°F)
Max. Pressure	20kgf/cm <sup>2</sup>
Shaft speed	V-20m/s

## Gland Packing

### JIC 3076

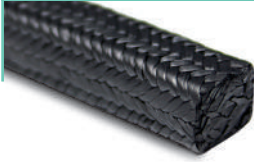

#### PTFE / Graphite Fiber Packing

흑연입 테프론 섬유 패킹

Consisting of PTFE / Graphite and lubricant are braided into square section. Good chemical resistant and heat resistant. Excellent self-lubricating, thermal conductive and low frictional co-efficient packing with no damage to shaft. Suitable for corrosive fluids, organic solvents, steam, hot water, oil, rotary machines, valves, rotary pump, agitator, flange, etc..

PTFE에 흑연을 분산시켜 만든 첨단 섬유로 편조하여, PTFE가 지닌 내약품성과 고순도의 흑연이 지닌 내열성이 잘 조화되어 내열, 내약품성이 우수, 자기 윤활성도 우수하여 저마찰성이며, 특히 Shaft를 손상시키지 않는 패킹, 부식성유체, 유기용제, 증기, 열수, 각종 기름, 회전기기, 밸브, 회전 펌프, 교반기 등에 사용.



pH	0 ~ 14
Max. Temp.(°C)	260 (500°F)
Max. Pressure	20kgf/cm <sup>2</sup>
Shaft speed	V-16m/s

### JIC 3076W



#### PTFE Fiber Packing

충진제입 테프론 섬유 패킹

PTFE fiber yarns are impregnated with special white filler and heat resistant lubricant, are braided into square section. Excellent thermal conductive and low frictional co-efficient packing with no damage to shaft. Suitable for a shaft seal for rotary pumps & equipments for food and medicine industries.

백색충진제와 윤활유를 함유한 테프론 섬유를 단면각형으로 편조한 패킹. 열팽창, 열전도, 내화학약품성이 뛰어나며 패킹에 의한 축마모가 거의 없어 순수 테프론 그랜드 패킹보다 고주속에서 사용가능.



pH	0 ~ 14
Max. Temp.(°C)	260 (500°F)
Max. Pressure	20kgf/cm <sup>2</sup>
Shaft speed	V-16m/s

## Hatch Cover Packing

### JIC 3069



#### Hatch Cover Packing

해치카바 패킹

Special packing for hatch cover made of excellent elastic rubber, chemical resistant synthetic fiber and PTFE fiber. This shows excellent sealing performance even under low seating stress without deformation for repeated usage. Order made product.

탄력성이 우수한 특수고무에 내약품성이 우수한 섬유를 편조한 후 PTFE Yam으로 편조한 제품으로 낮은 체부압에도 우수한 Seal성을 발휘하며, 반복하여 사용하여도 변형이 거의 없는 Hatch Cover 전용의 패킹.



pH	0 ~ 14
Max. Temp.(°C)	100

### JIC 3069-GS



#### Hatch Cover Packing

해치카바 패킹

Same as JIC 3069 but, using high-grade core rubber tube and PTFE tapes and improving work-process to be suitable for the use of Gas application. Excellent sealing performance in Gas lines.

중심에 탄력성이 있는 합성고무 Tube와 Cushion재로는 특수합성 섬유로 여러겹 편조하고 특수 윤활제가 처리된 PTFE Yam으로 편조한 Chemical Tank 및 선박용 Hatch Cover 패킹. JIC 3069-GS는 Product Carrier선의 Chemical Tank Hatch Cover의 Sealing용으로 특수 제작된 패킹.



Max. Temp.(°C)	100
Applied Fluids	Oil refined products, animal or vegetable oil, acid, alkali, oil, brine, etc.

## Carbon Fiber Packing

### JIC 3072

#### Inconel Wire Inserted Carbon Fiber Packing

인코넬선입 탄소 섬유 패킹



Carbon fiber yarns with inconel wire insertion are square-braided. Anti-corrosive material is treated. Suitable for high temperature & high pressure valve packing. Mainly used in combination with JIC 4101.

탄소섬유로 편조하면서 인코넬선으로 보강한 내열성 패킹. 비석면 제품에 방식처리제로 도포되었다. 고온, 고압용, 밸브패킹용 등에 사용된다. JIC 4101과 병합 사용.



pH	2 ~ 12
Max. Temp.(°C)	450 (840°F)
Max. Pressure	100kgf/cm <sup>2</sup>

### JIC 3074

#### PTFE Impregnated Carbon Fiber Packing

테프론 함침 탄소 섬유 패킹



Carbon fiber yarns are square-braided and then impregnated with PTFE dispersion. It shows excellent heat resistance, chemical resistance and thermal conductivity. High friction thermal conductivity, superior heat radiation and long life by self-lubricating. Suitable for strong acid, strong alkali, hydrocarbon, organic solvents, hot oil, steam, etc.

탄소섬유로 편조하고 PTFE Dispersion 윤활유로 처리하여 격자편으로 편조한 패킹. 내열, 내약품성이 우수한 것은 물론, 열전도성이 양호하며, 자기 윤활성을 갖고 마찰열의 방산이 용이하고 수명이 길다. 강산, 강알카리, 탄화수소, 유기용제, 열유, 증기 등에 사용.



pH	2 ~ 12
Max. Temp.(°C)	300 (570°F)
Max. Pressure	50kgf/cm <sup>2</sup>

### JIC 3074-CR

#### Lubricated Carbon Fiber Packing

윤활유입 탄소섬유 패킹



Carbon fiber yarns are impregnated with special heat resistant lubricant, lattice-braided into a packing and then, retreated on the surface with Graphite. It shows excellent heat resistance, chemical resistance and thermal conductivity. High friction thermal conductivity and long life by self-lubricating. Mainly used in combination with JIC 4101.

탄소섬유를 특수 내열 윤활제로 함침하고, 격자편으로 편조한 후 표면을 흑연처리한 패킹. 내열, 내약품성이 우수하며, 열전도성이 양호하다. 자기 윤활성이 있어 마찰열의 방산이 용이하고, 수명이 길다. 주로 JIC 4101과 병합 사용.



pH	2 ~ 12
Max. Temp.(°C)	450 (840°F)
Max. Pressure	100kgf/cm <sup>2</sup>

### JIC 3075

#### Lubricated PTFE Impregnated Carbon Fiber Packing

윤활유입 테프론 함침 탄소 섬유 패킹

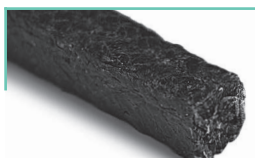

Carbon fiber yarns are square-braided, impregnated with PTFE dispersion and lubricant. Excellent heat resistant and chemical resistant packing. Suitable for corrosive fluids, organic solvents, steam, hot water, hydrocarbon, oil, rotary machine, valve, rotary pump, agitator, flange, etc.

탄소섬유로 편조하고 PTFE Dispersion을 함침시킨 패킹. 내열, 내약품성이 우수한 것은 물론, 열전도성이 양호하며, 마찰열의 방산이 용이하고 수명이 길다. 부식성 유체, 유기용제, 증기, 열수, 탄화수소, 각종 기름, 회전기기, 밸브, 회전펌프, 교반기 등에 사용.



pH	2 ~ 12
Max. Temp.(°C)	300 (570°F)
Max. Pressure	20kgf/cm <sup>2</sup>
Shaft Speed	V-15m/s



## Carbonized Fiber Packing

### JIC 3094



#### PTFE Impregnated Carbonized Fiber Packing

테프론 함침 탄화 섬유 패킹

Pan-carbonized fiber yarns are square or lattice-braided and impregnated with PTFE dispersion and lubricant. Light and excellent self-lubricating packing. Suitable for acid, alkaline fluids, brine, industrial waste water, mineral oil, vegetable oil, valve, etc.

유연하고 강인한 PAN계의 탄화섬유를 8편 또는 격자편으로 편조하고 PTFE Dispersion을 함침시킨 패킹. 산, 알칼리용액, 해수, 공업폐수, 광물유, 동식물유, 벨브용 등에 사용.



pH	2 ~ 12
Max. Temp.(°C)	200 (390°F)
Max. Pressure	50kgf/cm <sup>2</sup>

### JIC 3095



#### Lubricated PTFE Impregnated Carbonized Fiber Packing

윤활유입 테프론 함침 탄화 섬유 패킹

Pan-carbonized fiber yarns are square or lattice-braided. Impregnated with PTFE dispersion and lubricated. Very light and self-lubricating packing. Suitable for acid, alkaline fluids, brine, industrial waste water, pumps, etc.

탄화섬유를 8편 또는 격자편으로 편조하고 PTFE Dispersion과 특수 윤활제를 함침시킨 패킹. 경량이며 자기 윤활성이 우수한 제품이다. 산, 알칼리 용액, 해수, 공업폐수, 펌프용 등에 사용.



pH	2 ~ 12
Max. Temp.(°C)	200 (390°F)
Max. Pressure	15kgf/cm <sup>2</sup>
Shaft speed	V-16m/s

## PTFE / Graphite Fiber and Aramid Fiber Packing

### JIC 3077

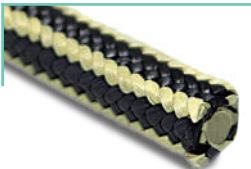

#### PTFE / Graphite Fiber and Aramid Fiber Packing

흑연입 테프론 섬유 및 아라미드 섬유 혼합 패킹

PTFE / Graphite fiber yarns and aramid fiber yarns are braided in combination. Excellent heat resistant, chemical resistant and self-lubricating packing. Suitable for corrosive fluids, organic solvents, steam, hot water, oil, rotary machine, rotary pumps, agitator, etc.

PTFE에 흑연을 분산시켜 만든 첨단의 섬유와 PTFE Dispersion 및 내열성 윤활유를 함침시킨 아라미드 섬유를 혼합 편조한 패킹. 내열성, 내약품성, 자기윤활성이 우수한 패킹. 부식성유체, 각종 유기용제, 증기, 열수, 각종 기름, 회전기기, 회전펌프, 교반기 등에 주로 사용.



pH	2 ~ 14
Max. Temp.(°C)	260 (500°F)
Max. Pressure	20kgf/cm <sup>2</sup>
Shaft speed	V-16m/s

### JIC 3080



#### Lubricated PTFE Impregnated Aramid Fiber Packing

윤활유입 테프론 함침 아라미드 섬유 패킹

Aramid fiber yarns produced by DuPont are square or lattice-braided. Impregnated with PTFE dispersion and lubricated. Suitable for water, brine, exhaust water acid, alkali, oil fluid, solvents, rotary pumps, chemical pumps, agitator, etc.

아라미드 섬유를 8편 또는 격자편으로 편조하고 PTFE Dispersion과 내열성 윤활유를 함침시킨 패킹. 물, 해수, 공업폐수, 산·알칼리용액, 각종 유계 유체, 용제, 일반 회전용펌프, 화학펌프, 교반기 등의 회전기기 등에 사용.



pH	3 ~ 11
Max. Temp.(°C)	260 (500°F)
Max. Pressure	20kgf/cm <sup>2</sup>
Shaft speed	V-10m/s

## Glass Fiber Packing

### JIC 3085

#### Inconel Wire Inserted Glass Fiber Packing

인코넬선입 유리섬유 패킹



Glass fiber yarns with inconel wire insertion are lubricated, braided and then Graphite treated. Excellent heat, chemical, pressure resistant and suitable for valves under high temperature and pressure. Mainly used in combination with JIC 4101.

인코넬선입 유리섬유를 특수윤활제로 처리하여 편조한 다음 표면을 흑연으로 처리하여 내열, 내압, 내약품성이 우수하고 고온·고압의 밸브용 패킹이다. 주로 JIC 4101과 병합 사용.



pH	3 ~ 11
Max. Temp.(°C)	450 (840°F)
Max Pressure	150kgf/cm <sup>2</sup>

## STARFOIL<sup>®</sup> Molded Packing

### JIC 4101

#### STARFOIL<sup>®</sup> (Graphite) Molded Packing | 팽창 흑연 성형 패킹

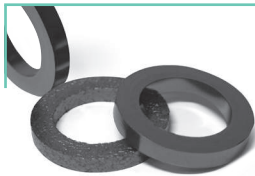

STARFOIL<sup>®</sup> (natural pure graphite) with a wide range of service temperature is made into compression mold ring packing. Especially there is little creep relaxation and temperature loss. Suitable for high temperature and high pressure steam, hot water, gas, hot oil, hot hydrocarbon, organic solvents, cryogenic fluids, LNG, valves, pumps, etc.

Graphite를 금형으로 일정한 치수로 압축 성형한 링-패킹. 순수 천연 흑연 패킹이므로 저온에서 고온 영역까지 사용 가능. 특히 응력완화 및 열감량 현상이 거의 없다. 고온·고압증기, 열수, Gas, 열유, 고온 탄화수소, 유기용제, 극저온유체, LNG 등 Valve용 및 Pump용으로 사용.



pH	0 ~ 14
Service Temp. Range (°C)	-240 ~ 450 (Oxidizing Atmosphere) -240~1650 (Non-Oxidizing Atmosphere)
Max Pressure	350kgf/cm <sup>2</sup>

## Anti - VOC(Volatile Organic Compound) Packing Set

### JIC 4101-VOC

#### Anti - VOC Packing Set | 휘발성 유기화학 물질 억제 패킹



Nowadays the environmental problems have been more considerably recognized all over the world and many companies have been trying to comply with ISO 14000 program. Especially as the Volatile Organic Compounds (VOC) was known as the main cause of ozone and stink generation, the protective regulations and have been more reinforced against the whole process of oil and acts petrochemical products. ANTI-VOC packing (AVP) is a kind of environment-friendly packing designed to minimize the leakage of VOC.

휘발성 유기 화합물인 각종 유기 용제류, Gas류, Hot Water, Hot Oil, 극저온 액화 가스(LNG, LPG 등) 각종 화학약품, 고온, 고압의 증기 등 다방면에 사용이 가능.



pH	0 ~ 14
Service Temp. Range (°C)	-240 ~ 450 (Oxidizing Atmosphere) -240 ~ 450 (Non-Oxidizing Atmosphere)
Max Pressure	350kgf/cm <sup>2</sup>

## Applications



# Gland Packing

## [pH Values]

The scientific shorthand for indicating the level of acidity or alkalinity of a substance is the pH value. The scale is logarithmic, making lye, at 13, ten times as alkaline as ammonia at 12.

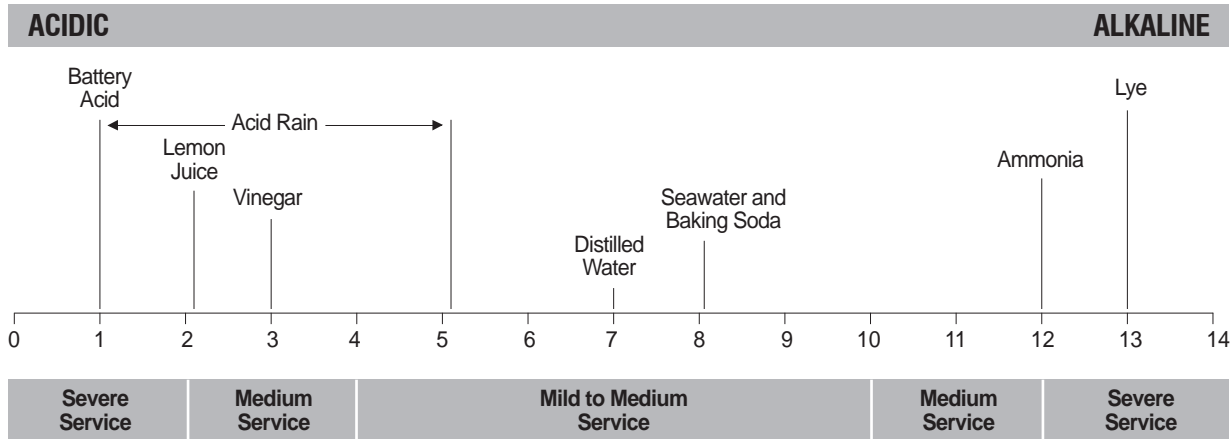

## [Properties]

JIC No.	Material Classification	Temp.		Pressure (Max.)	Valves	Centrifugal pumps	Pistons	Chemicals	Shaft Speed	pH
		°F	°C							
3020	Expanded Graphite yarn		-200°C to 600°C	200kgf/cm <sup>2</sup>	O	O	O	O		0-14
3020-I	INCONEL wire inserted Expanded Graphite yarn		-200°C to 600°C	260kgf/cm <sup>2</sup>	O	X	X	O		0-14
3063	PTFE fiber	To 500°F	To 260°C	100kgf/cm <sup>2</sup>	O	X	O	O		0-14
3064	PTFE fiber	To 500°F	To 260°C	20kgf/cm <sup>2</sup>	X	O	O	O	10m/s	0-14
3065	PTFE fiber&Aramid fiber	To 500°F	To 260°C	20kgf/cm <sup>2</sup>	X	O	O	O	16m/s	0-14
3067	PTFE fiber&Graphite fiber	To 500°F	To 260°C	20kgf/cm <sup>2</sup>	X	O	O	O	20m/s	0-14
3076	PTFE fiber	To 570°F	To 260°C	20kgf/cm <sup>2</sup>	O	O	O	O	16m/s	0-14
3076W	PTFE fiber	To 570°F	To 260°C	20kgf/cm <sup>2</sup>	O	O	O	O	16m/s	0-14
3069	PTFE yarn		To 100°C		X	X	X	O		0-14
3069-GS	PTFE yarn		To 100°C		X	X	X	O		
3072	INCONEL wire inserted carbon fiber	To 840°F	To 450°C	100kgf/cm <sup>2</sup>	O	X	X	X		2-12
3074	Carbon Fiber	To 570°F	To 300°C	50kgf/cm <sup>2</sup>	O	X	X	X		2-12
3074-CR	Carbon Fiber	To 840°F	To 450°C	100kgf/cm <sup>2</sup>	O	X	X	X		2-12
3075	Carbon Fiber	To 570°F	To 300°C	20kgf/cm <sup>2</sup>	O	O	O	X	15m/s	2-12
3094	Carbonized Fiber	To 390°F	To 200°C	50kgf/cm <sup>2</sup>	O	X	X	X		2-12
3095	Carbonized Fiber	To 390°F	To 200°C	15kgf/cm <sup>2</sup>	X	O	O	X	16m/s	2-12
3077	PTFE fiber&Aramid fiber	To 500°F	To 260°C	20kgf/cm <sup>2</sup>	X	O	O	O	16m/s	2-14
3080	Aramid Fiber	To 500°F	To 260°C	20kgf/cm <sup>2</sup>	X	O	O		10m/s	3-11
3085	INCONEL wire inserted glass Fiber	To 840°F	To 450°C	150kgf/cm <sup>2</sup>	O	X	X	X		3-11
4101	Graphite		-240°C to 450°C -240°C to 1650°C (Non-Oxidizing Atmosphere)	350kgf/cm <sup>2</sup>	O	O	X	X		0-14
4101-VOC	Graphite		-240°C to 450°C	350kgf/cm <sup>2</sup>	O	X	X	O		0-14 (without strong acid)



# Rubber Sheets & Gaskets

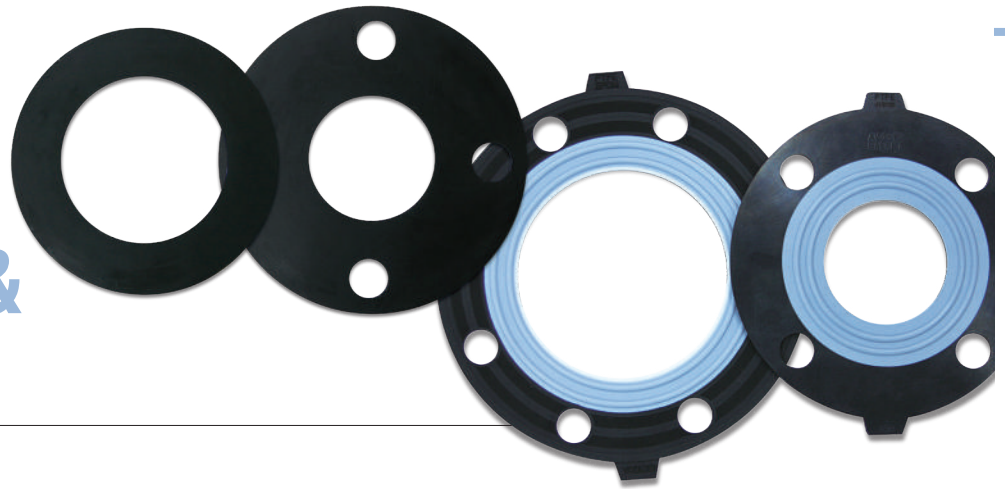

## JIC 9000 / 9001

### [Characteristic]

Elastomeric gaskets provide excellent compressibility & recovery and have relatively soft compression characteristics and can show good sealing performance even under low stress load.

Recommend varying types of elastomers to be suitable for required diverse operating chemicals and temperature.

탄력있는 고무재질로 압축, 복원성, 작업성이 좋고 낮은 체부압에서도 안정적인 Sealing 성능을 유지하는 고무시트 가스켓, 각종 기관의 Flange기구 등의 가스켓으로 유체의 종류에 맞는 재질을 선정하여야 한다.

### [Application]

<b>Maximum Service Temp.</b>	Depending on elastomers used.
<b>Maximum Service Pressure</b>	10kgf/cm <sup>2</sup> (150psi)
<b>Materials</b>	NR, NBR, CR, EPDM, SL, SBR, VITON, BUTYL
<b>Size</b>	1/32"(0.8mm), 1/16"(1.5mm), 1/8"(3.0mm), 3/16"(5.0mm)

\*Other Sizes can be available, if required

### [Typical Physical Properties]

Code	Typical Properties	Temp.range(°C)
NR	Natural Rubber (Excellent mechanical properties)	-20 ~ 100
NBR	Acrylonitrile Butadiene Rubber (Excellent oil resistance)	-30 ~ 120
CR (NEOPRENE)	Chloroprene Rubber (Excellent weather, ozone, heat & flame resistance)	-30 ~ 120
EPDM	Ethy lene Propylene Diene Monomer (Excellent ageing & ozone resistance)	-40 ~ 150
SL (SILICONE)	Silicone Rubber (Excellent in heat, cold & chemical resistance)	-60 ~ 200
SBR	Styrene Butadiene Rubber (Excellent in ageing & abrasion resistance)	-20 ~ 100
FKM (VITON)	Fluoroelastomer (Superior in heat, oil & chemical resistance)	-20 ~ 200
IIR (BUTYL)	Isobutylene Isoprene Rubber (Excellent ozone, weather, electricity resistance)	-40 ~ 120

## JIC 9010-EPDM

### [Characteristic]

The composition of JIC 9010 is integrated EPDM with pressurized and heated Fluoroplastic film and characteristic of rubber elasticity and PTFE heat and chemical resistance perform excellent sealing ability. Industrial fields requiring high cleanness and purification in electronics, food, pharmaceutical etc.

EPDM고무를 중심재로 해서 불소 수지 필름을 가압 가열 성형하고, 일체형으로 밀착시킨 가스켓으로 고무의 탄성과 PTFE의 내열성, 내약품성을 겸하여 갖추고 있으며, Sealing이 우수한 가스켓 전자, 식품, 의약 제품과 같이 높은 청결성이 요구되는 산업 분야.

### [Application]

<b>Maximum Service Temp.</b>	-30~150°C
<b>Maximum Service Pressure</b>	20kgf/cm <sup>2</sup> (300psi)
<b>Materials</b>	EPDM
<b>Size</b>	1/32"(0.8mm), 1/16"(1.5mm), 1/8"(3.0mm), 3/16"(5.0mm)

\*Other Sizes can be available, if required

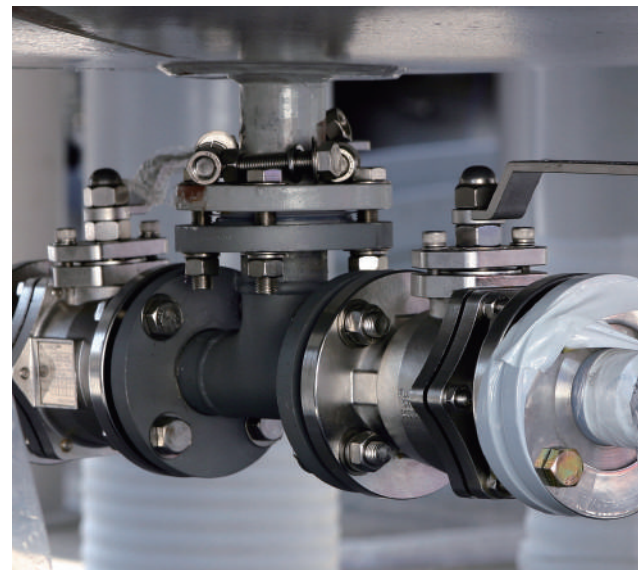

[ Products Description ]

JIC 900 -  -

**Material Codes**

Normal Type : 0 / Serrated Type : 1

**Products symbols**

NR / NBR / CR(NEOPRENE) / EPDM /  
SL(SILICONE) / SBR / FKM(VITON) / IIR(BUTYL)

[Properties & Chemical Resistance]

	NR	NBR	CR (NEOPRENE)	EPDM	SL	SBR	FKM(VITON)	BUTYL(IIR)
Hardness(Shore A))	70±5	60±5	60±5	75±5	65±5	60±5	75±5	60±5
Tensile Strength(kgf/cm <sup>2</sup> )	min.70	min.80	min.60	min.152	min.80	min.30	min.93	min.70
Elongation(%)	min.150	min.300	min.350	min.240	min.100	min.150	min.220	min.350
Rebound Resilience	◎	○	◎	○	◎	○	△	△
Service Temp.(°C)	-20~100	-30~120	-30~120	-40~150	-60~200	-20~100	-20~200	-40~120
Wear Resistance	○	◎	○	△	△	◎	○	△
Flexibility	◎	○	○	○	△	○	○	◎
Ozone Resistance	X	X	○	◎	◎	X	◎	◎
Gas permeability	△	○	○	△	X	△	○	◎
Flame Resistance of Salt Tolerance	X	X	○	X	△	X	◎	X
Lubricant	X	◎	○	X	○	X	◎	X
Gasoline	X	○	△	X	X	X	◎	X
Aliphatic Hydrocarbon	X	◎	○	X	X	X	◎	X
Hydrocarbon	X	X	X	X	X	X	○	X
Aromatic hydrocarbon	X	X	X	X	X	X	◎	X
Alcohol	◎	◎	◎	◎	△	◎	○	◎
Ketone	○	○	◎	◎	○	○	△	◎
Water	◎	◎	◎	◎	◎	◎	◎	◎
Weak Acid	○	○	◎	◎	○	○	◎	◎
Strong Acid	X	X	△	○	X	X	◎	○
Alkali	○	○	◎	◎	○	○	△	◎

Note : ◎ Excellent / ○ Good / △ Suitable / X Unsuitable ◎우수 / ○양호 / △가능 / X불가



# Insulation Sets

- JIC 7700-R** TYPE 'R' - Raised Face
- JIC 7700-F** TYPE 'F' - Full Face
- JIC 7700-RJ** TYPE 'RJ' - R.T.J

### [Characteristic]

Insulation sets are used for pipeline flange corrosion protection and for complete electrical insulation protection where a seal is required between dissimilar flange materials.

There are three standard styles available to suit raised face, full face and ring grooved flanges.

지하배관과 지상배관 사이의 전기적 보호를 위하여 사용하는 제품. 지하배관을 통하여 지상으로 유입되는 전류를 차단하여 쇼크로 인한 인명 피해를 방지하며, 전위차로 인한 지하매설물 및 이종재질로 연결된 배관의 전기적 이온부식을 방지함.

### [Standard Styles of Insulation Sets]

#### Raised Face Type

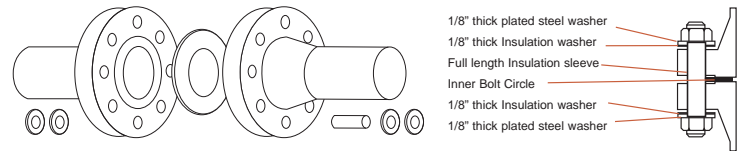

#### Full Face Type

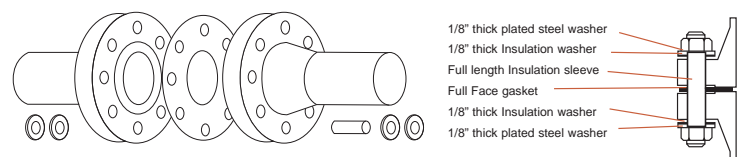

#### R.T.J Type

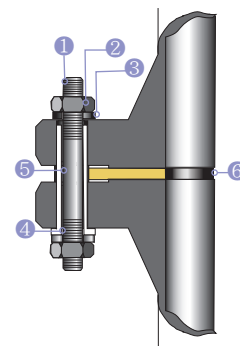
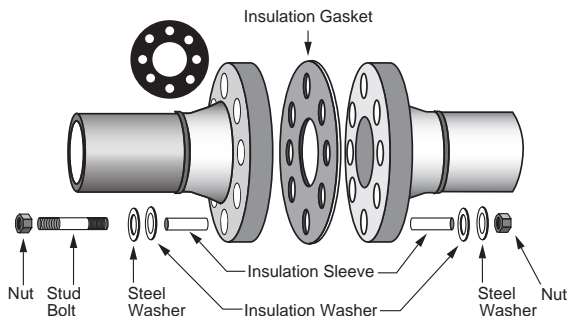
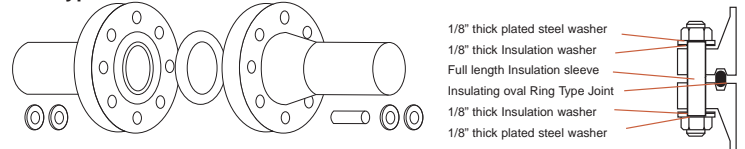

- ① Nut
- ② Stud Bolt
- ③ Insulation Washer
- ④ Steel Washer
- ⑤ Insulation Sleeve
- ⑥ Insulation Gasket



## Gasket

JIC CODE / EQ	Max. Temp. (°C)	Insulation Resistance (Ω)
	Pressure Class (lb)	
<b>JIC 8305</b> PTFE Solid Gasket	-100 ~ 100	Over $2.0 \times 10^{13}$
	150	
<b>JIC 8305G</b> Reinforced PTFE Gasket	-200 ~ 200	$1.3 \times 10^{11}$
	300	
<b>JIC 9020-CP</b> Neoprene Faced Phenolic Gasket	-30 ~ 120	CR $1.6 \times 10^7$
	150	
<b>JIC 9210-ER</b> <b>STARTEC™</b> Gasket (Glass Reinforced Epoxy Plate Gasket with Rubber O-Ring)	-40 ~ 150	EPDM $2.0 \times 10^{13}$
	600	
<b>JIC 9220-PR</b> <b>STARTEC™</b> Gasket (Glass Reinforced Phenolic Plate Gasket with Rubber O-Ring)	-40 ~ 150	R U B B E R  VITON $9.7 \times 10^9$
	600	
<b>JIC 9230-ES</b> <b>STARTEC™</b> Gasket (Glass Reinforced Epoxy Plate Gasket with Rubber O-Ring) EQ : PIKOTEK PGE TYPE	-60 ~ 150	NBR $1.3 \times 10^{11}$
	600	
<b>JIC 9310-OS</b> <b>STARTEC™</b> Gasket (Epoxy Faced Metal Plate with Rubber O-Ring) EQ : PIKOTEK VCS TYPE	150	-
	1500	
<b>JIC 9320-OS</b> <b>STARTEC™</b> Gasket (Epoxy Faced Metal Plate with PTFE Seal) EQ : PIKOTEK VCS Type	150	Over $2.0 \times 10^{13}$
	2500	
<b>JIC 3850-SE(HT)</b> KAMMPROFILE Gasket with <b>STARPITE®</b>	1000	$9.9 \times 10^{10}$
	2500	

\* Insulation Resistance(Ω) ASTM D257-07 :  
Usage Voltage : 1000V,  
Capacity of Tester :  $2.0 \times 10^{13} \Omega$   
\* Gasket type confirmed by customer.  
\* For Specific size & application  
recommendations consult JEIL.  
\* PTFE Gasket : Not suitable for FR type.



## Bolt / Nut / Sleeve / Washer

		Insulation Resistance (Ω)	Max. Temp. (°C)	Thickness
Insulation Sleeve	Glass Reinforced EPOXY (G-10, G-11)	Over $2.0 \times 10^{13}$	180	0.8T ~ 1.0T
	Phenolic	$2.2 \times 10^8$	180	
	PTFE	Over $2.0 \times 10^{13}$	100	
	Mica	$9.9 \times 10^{10}$	1000	
Insulation Washer	Glass Reinforced EPOXY	Over $2.0 \times 10^{13}$	150	3.0T
	Phenolic	$2.2 \times 10^8$	180	
	Mica	$9.9 \times 10^{10}$	1000	
Steel Washer	Carbon Steel	N/A	N/A	3.0T ~ 5.0T
	Stainless Steel	N/A	N/A	
Nut (Heavy Hex Nut)	A194 Gr.2H (ASTM)	N/A	N/A	-
	A194 Gr.8 (ASTM)	N/A		
	A194 Gr.8M (ASTM)	N/A		
Bolt (Stud Bolt)	A193 Gr.B7 (ASTM)	N/A	N/A	-
	A193 Gr.B8 (ASTM)	N/A		
	A193 Gr.B8M (ASTM)	N/A		

\* Insulation Resistance(Ω) ASTM D257-07: Usage Voltage: 1000V, Capacity of Tester :  $2.0 \times 10^{13} \Omega$   
\* Steel Washer, Nut, Bolt : Special Material can be available as customer's requirements.

# Appendix

## Gasket Installation Procedure

### Gasket Recommended Assembly Stress & Torque Values

### Gasket Standard Dimension Table

Non-Metallic Gaskets Dimension  
Spiral Wound Gaskets Dimension  
Ring Joint Gaskets Dimension  
Kammprofile Gaskets Dimension

### Gasket Chemical Resistance Chart

### Gasket Materials and Contact Facings

## Gasket Installation Procedure

### 1. Install Gasket

- Ensure gasket is the specified size and material.
- Examine the gasket to ensure it is free of defects.
- Carefully insert the gasket between the flanges.
- Make sure the gasket is centered between the flanges.
- Bring flanges together, ensuring the gasket isn't pinched damaged.

#### 1. 가스켓 장착

- 가스켓이 지정된 사이즈와 재료로 제작되었는지 확인한다.
- 가스켓의 결함 여부를 확인한다.
- 플랜지 사이에 가스켓을 조심스럽게 끼운다.
- 가스켓이 플랜지 센터 부분에 위치했는지 확인한다.
- 가스켓이 잘못 끼워지거나 손상되지 않도록 확인하면서 플랜지를 장착한다.

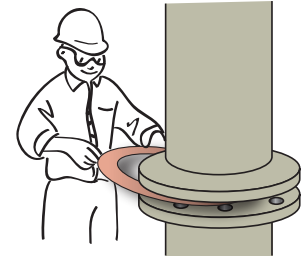

### 2. Install and tighten fasteners

#### a. Always use proper tools

Calibrated torque wrench or other controlled tensioning device

#### b. Consult your gasket manufacturer

for guidance on torque specifications

#### c. Always torque in a cross bolt tightening pattern.

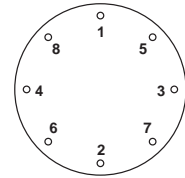

### 2. 결속용구 장착과 조임

- 항상 적절한 기구를 사용한다.
- 토크 지침 안내에 관해서는 가스켓 제조업체와 상의한다.
- 볼트 조임시 항상 대각선 방향 순서로 한다.

## Gasket Recommended Assembly Stress &amp; Torque Values

## 3. Tighten the nuts in multiple steps

- Step 1.** Tighten all nuts initially by hand (Larger bolts may require a small hand wrench)
- Step 2.** Torque each nut to ~30% of full torque
- Step 3.** Torque each nut to ~60% of full torque
- Step 4.** Torque each nut full torque, again still using the cross bolt tightening pattern (larger diameter flanges may require additional tightening passes)
- Step 5.** Apply at least one final torque to all nuts in a clockwise direction until all torque is uniform (Larger diameter flanges may require additional passes)

## 3. 다단계 너트 조임

- 1단계. 모든 너트를 처음에는 손으로 조인다.  
(큰 볼트는 작은 핸드렌치를 사용할 수 있다.)
- 2단계. 30%까지 각 너트를 조인다.
- 3단계. 60%까지 각 너트를 조인다.
- 4단계. 대각선 순서로 완전히 너트를 조인다. (대구경 플랜지는 추가로 조임을 준다.)
- 5단계. 모든 토크가 균일하게 될 때까지 시계방향으로 볼트를 최종적으로 조인다.

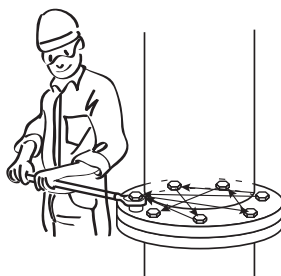

## 4. Re-Tightening

## A. Caution

Consult your gasket manufacture for guidance and recommendations re-tightening.

- B-1. Do Not** Re-torque elastomer-based, non-asbestos gaskets after they have been exposed to elevated temperature unless otherwise specified.
- B-2.** Re-torque fasteners exposed to aggressive thermal cycling.
- B-3.** All re-torquing should be performed at ambient temperature and atmospheric pressure.

## 4. 재조임

- A. 주의 - 재조임에 관한 안내 및 유의사항에 관해서는 가스켓 제조업체와 상의한다.
- B-1. 달리 규정되어 있지 않으면 상승된 온도에 노출된 후에는 고무가 함유된 비석면 가스켓은 재조임을 하지 않는다.
- B-2. 심각한 열변화에 노출된 조임부분은 재조임을 한다.
- B-3. 모든 재조임은 대기온도 및 대기압에서 이루어져야 한다.

Stress = 30,000 psi

Nominal Dia. of Bolt(Inch)	Torque Value (kgf.cm)	Torque Value (ft.lbs)	Torque Value (Nm)
1/2	416	30	41
9/16	619	45	61
5/8	831	60	82
3/4	1,369	100	135
7/8	2,201	160	217
1	3,367	245	332
1 1/8	4,878	355	481
1 1/4	6,876	500	678
1 3/8	9,350	680	922
1 1/2	11,003	800	1,085
1 5/8	15,121	1,100	1,491
1 3/4	20,627	1,500	2,034
1 7/8	27,503	2,000	2,712
2	30,252	2,200	2,983
2 1/4	43,729	3,180	4,312
2 1/2	60,503	4,400	5,966
2 3/4	81,394	5,920	8,026
3	106,129	7,720	10,465
3 1/4	115,500	8,400	11,389
3 1/2	123,744	9,000	12,202
3 3/4	131,999	9,600	13,016
4	1,137,496	10,000	13,558

1) Table are based on the use of the min. assembly stress 7500psi  
2) All data are typical values.



## Gasket Standard Dimension Table

### Non-Metallic Gaskets Dimension

ASME B 16.21(2011)

FF(Full Face) : ASME / ANSI B 16.5 Pipe Flanges

[Unit : mm]

Size (NPS)	Class 150				
	I.D	O.D	B.C.D	H	N
1/2	21	89	60.3	15.7	4
3/4	27	98	69.9	15.7	4
1	33	108	79.4	15.7	4
1-1/4	42	117	88.9	15.7	4
1-1/2	48	127	98.4	15.7	4
2	60	152	120.7	19.1	4
2-1/2	73	178	139.7	19.1	4
3	89	191	152.4	19.1	4
3-1/2	102	216	177.8	19.1	8
4	114	229	190.5	19.1	8
5	141	254	215.9	22.4	8
6	168	279	241.3	22.4	8
8	219	343	298.5	22.4	8
10	273	406	362.0	25.4	12
12	324	483	431.8	25.4	12
14	356	533	476.3	28.4	12
16	406	597	539.8	28.4	16
18	457	635	577.9	31.8	16
20	508	699	635.0	31.8	20
24	610	813	749.3	35.1	20

- 1) B.C.D : Bolt Circle Diameter
- 2) H : Bolt hole Diameter
- 3) N : Number of Bolt hole

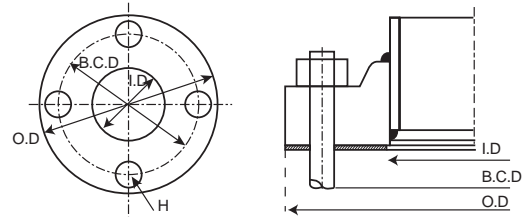

ASME B 16.21(2011)

RF(Flat Ring) : ASME / ANSI B 16.5 Pipe Flanges

[Unit : mm]

Size (NPS)	Gasket I.D	Gasket O.D				
		Class 150	Class 300	Class 400	Class 600	Class 900
1/2	21	48	54	54	54	64
3/4	27	57	67	67	67	70
1	33	67	73	73	73	79
1-1/4	42	76	83	83	83	89
1-1/2	48	86	95	95	95	98
2	60	105	111	111	111	143
2-1/2	73	124	130	130	130	165
3	89	137	149	149	149	168
3-1/2	102	162	165	162	162	-
4	114	175	181	178	194	206
5	141	197	216	213	241	248
6	168	222	251	248	267	289
8	219	279	308	305	321	359
10	273	340	362	359	400	435
12	324	410	422	419	457	498
14	356	451	486	483	492	521
16	406	514	540	537	565	575
18	457	549	597	594	613	638
20	508	606	654	648	683	699
24	610	718	775	768	791	838

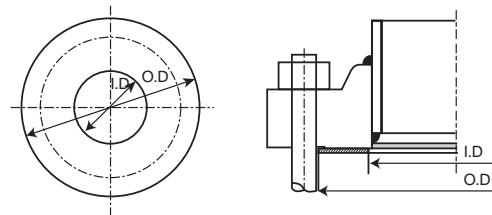

## Gasket Standard Dimension Table

### Non-Metallic Gasket Dimension

ASME B 16.21(2011)

RF(Flat Ring) : ASME B 16.47 Series "A" Large Diameter Steel Flanges (MSS SP-44 Flanges)

[Unit : mm]

Size (NPS)	Gasket I.D	Gasket O.D			
		Class 150	Class 300	Class 400	Class 600
22	559	660	705	702	733
26	660	775	835	832	867
28	711	832	899	892	914
30	762	883	953	946	972
32	813	940	1006	1003	1022
34	864	991	1057	1054	1073
36	914	1048	1118	1118	1130
38	965	1111	1054	1073	1105
40	1016	1162	1114	1127	1156
42	1067	1219	1165	1178	1219
44	1118	1276	1219	1232	1270
46	1168	1327	1273	1289	1327
48	1219	1384	1324	1346	1391
50	1270	1435	1378	1403	1448
52	1321	1492	1429	1454	1499
54	1372	1549	1492	1518	1556
56	1422	1607	1543	1568	1613
58	1473	1664	1594	1619	1664
60	1524	1715	1645	1683	1721

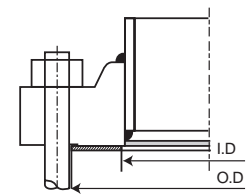
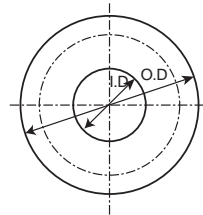

ASME B 16.21(2011)

RF(Flat Ring) : ASME / ANSI B 16.47 Series "B" Large Diameter Steel Flanges (API 605 Flanges)

[Unit : mm]

Size (NPS)	Gasket I.D	Gasket O.D				
		Class 75	Class 150	Class 300	Class 400	Class 600
26	660	708	725	772	746	765
28	711	759	776	826	800	819
30	762	810	827	886	857	879
32	813	860	881	940	911	933
34	864	911	935	994	962	997
36	914	973	987	1048	1022	1048
38	965	1024	1045	1099	-	-
40	1016	1075	1095	1149	-	-
42	1067	1126	1146	1200	-	-
44	1118	1181	1197	1251	-	-
46	1168	1232	1256	1318	-	-
48	1219	1283	1307	1368	-	-
50	1270	1334	1357	1419	-	-
52	1321	1387	1408	1470	-	-
54	1372	1438	1464	1530	-	-
56	1422	1495	1514	1594	-	-
58	1473	1546	1580	1656	-	-
60	1524	1597	1630	1705	-	-

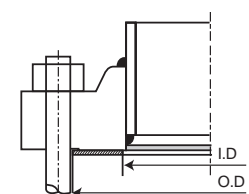
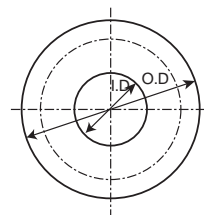

# Gasket Standard Dimension Table

## Non-Metallic Gaskets Dimension

KS B 1519 (2007), JIS B 2404 (2006)

Gasket Type : FF (Full Face)

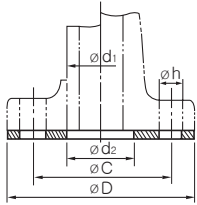

Full Face Type

[Unit : mm]

Size (NPS)	$d_2$	2 K				5 K				10 K				16 K			
		D	C	h	n	D	C	h	n	D	C	h	n	D	C	h	n
10	18	-	-	-	-	75	55	12	4	90	65	15	4	90	65	15	4
15	22	-	-	-	-	80	60	12	4	95	70	15	4	95	70	15	4
20	28	-	-	-	-	85	65	12	4	100	75	15	4	100	75	15	4
25	35	-	-	-	-	95	75	12	4	125	90	19	4	125	90	19	4
32	43	-	-	-	-	115	90	15	4	135	100	19	4	135	100	19	4
40	49	-	-	-	-	120	95	15	4	140	105	19	4	140	105	19	4
50	61	-	-	-	-	130	105	15	4	155	120	19	4	155	120	19	8
65	84	-	-	-	-	155	130	15	4	175	140	19	4	175	140	19	8
80	90	-	-	-	-	180	145	19	4	185	150	19	8	200	160	23	8
90	102	-	-	-	-	190	155	19	4	195	160	19	8	210	170	23	8
100	115	-	-	-	-	200	165	19	8	210	175	19	8	225	185	23	8
125	141	-	-	-	-	235	200	19	8	250	210	23	8	270	225	25	8
150	167	-	-	-	-	265	230	19	8	280	240	23	8	305	260	25	12
175	192	-	-	-	-	300	260	23	8	305	265	23	12	-	-	-	-
200	218	-	-	-	-	320	280	23	8	330	290	23	12	350	305	25	12
225	244	-	-	-	-	345	305	23	12	350	310	23	12	-	-	-	-
250	270	-	-	-	-	385	345	23	12	400	355	25	12	430	380	27	12
300	321	-	-	-	-	430	390	23	12	445	400	25	16	480	430	27	16
350	359	-	-	-	-	480	435	25	12	490	445	25	16	540	480	33	16
400	410	-	-	-	-	540	495	25	16	560	510	27	16	605	540	33	16
450	460	605	555	23	16	605	555	25	16	620	565	27	20	675	605	33	20
500	513	655	605	23	20	655	605	25	20	675	620	27	20	730	660	33	20
550	564	720	665	25	20	720	665	27	20	745	680	33	20	795	720	39	20
600	615	770	715	25	20	770	715	27	20	795	730	33	24	845	770	39	24
650	667	825	770	25	24	825	770	27	24	845	780	33	24	-	-	-	-
700	718	875	820	25	24	875	820	27	24	905	840	33	24	-	-	-	-
750	770	945	880	27	24	945	880	33	24	970	900	33	24	-	-	-	-
800	820	995	930	27	24	995	930	33	24	1020	950	33	28	-	-	-	-
850	872	1045	980	27	24	1045	980	33	24	1070	1000	33	28	-	-	-	-
900	923	1095	1030	27	24	1095	1030	33	24	1120	1050	33	28	-	-	-	-
1000	1025	1195	1130	27	28	1195	1130	33	28	1235	1160	39	28	-	-	-	-
1100	1130	1305	1240	27	28	1305	1240	33	28	1345	1270	39	28	-	-	-	-
1200	1230	1420	1350	27	32	1420	1350	33	32	1465	1380	39	32	-	-	-	-
1350	1385	1575	1505	27	32	1575	1505	33	32	1630	1540	45	36	-	-	-	-
1500	1540	1730	1660	27	36	1730	1660	33	36	1795	1700	45	40	-	-	-	-

1)  $d_2$  : Gasket Inside Diameter / 2) D : Gasket Outside Diameter / 3) C : Bolt Circle Diameter / 4) h : Bolt Hole Diameter / 5) n : Bolt Hole Number



## Gasket Standard Dimension Table

### Non-Metallic Gaskets Dimension

KS B 1519 (2007), JIS B 2404 (2006)

Gasket Type : RF (Flat Rling, Ring Type)

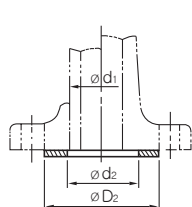

Full Face Type

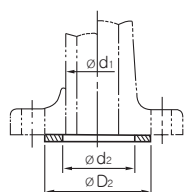

Raised Face Type

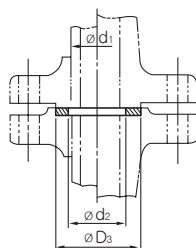

Male & Female Type

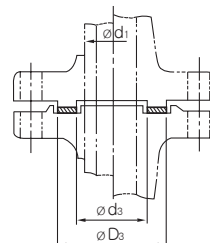

Tongue & Groove Type

[Unit : mm]

Size (NPS)	$d_2$	$D_2$									Male & Female Type	Tongue & Groove Type		
		Full Face Type, Raised Face Type										$D_3$	$d_3$	$D_3$
		2K	5K	10K	Tongue 10K	16K	20K	30K	40K	63K				
10	18	-	45	53	55	53	53	59	59	64	38	28	38	
15	22	-	50	58	60	58	58	64	64	69	42	32	42	
20	28	-	55	63	65	63	63	69	69	75	50	38	50	
25	35	-	65	74	78	74	74	79	79	80	60	45	60	
32	43	-	78	84	88	84	84	89	89	90	70	55	70	
40	49	-	83	89	93	89	89	100	100	108	75	60	75	
50	61	-	93	104	108	104	104	114	114	125	90	70	90	
65	77	-	118	124	128	124	124	140	140	153	110	90	110	
80	90	-	129	134	138	140	140	150	150	163	120	100	120	
90	102	-	139	144	148	150	150	163	163	181	130	110	130	
100	115	-	149	159	163	165	165	173	183	196	145	125	145	
125	141	-	184	190	194	203	203	208	226	235	175	150	175	
150	167	-	214	220	224	238	238	251	265	275	215	190	215	
175	192	-	240	245	249	-	-	-	-	-	-	-	-	
200	218	-	260	270	274	283	283	296	315	330	260	230	260	
225	244	-	285	290	294	-	-	-	-	-	-	-	-	
250	270	-	325	333	335	356	356	360	380	394	325	295	325	
300	321	-	370	378	380	406	406	420	434	449	375	340	375	
350	359	-	413	423	425	450	450	465	479	488	415	380	415	
400	410	-	473	486	488	510	510	524	534	548	475	440	475	
450	460	535	533	541	-	575	575	-	-	-	523	483	523	
500	513	585	583	596	-	630	630	-	-	-	575	535	575	
550	564	643	641	650	-	684	684	-	-	-	625	585	625	
600	615	693	691	700	-	734	734	-	-	-	675	635	675	
650	667	748	746	750	-	784	805	-	-	-	727	682	727	
700	718	798	796	810	-	836	855	-	-	-	777	732	777	
750	770	856	850	870	-	896	918	-	-	-	832	787	832	
800	820	906	900	920	-	945	978	-	-	-	882	837	882	
850	872	956	950	970	-	995	1038	-	-	-	934	889	934	
900	923	1006	1000	1020	-	1045	1088	-	-	-	987	937	987	
1000	1025	1106	1100	1124	-	1158	-	-	-	-	1092	1042	1092	
1100	1130	1216	1210	1234	-	1258	-	-	-	-	1192	1142	1192	
1200	1230	1326	1320	1344	-	1368	-	-	-	-	1292	1237	1292	
1300	1335	-	-	-	-	1474	-	-	-	-	1392	1337	1392	
1350	1385	1481	1475	1498	-	1534	-	-	-	-	1442	1387	1442	
1400	1435	-	-	-	-	1584	-	-	-	-	1492	1437	1492	
1500	1540	1636	1630	1658	-	1694	-	-	-	-	1592	1537	1592	

# Gasket Standard Dimension Table

## Spiral Wound Gaskets Dimension

### ASME B 16.20 (2007)

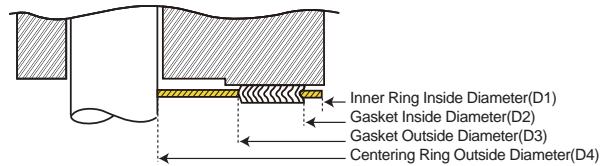

### ASME B16.5 Pipes Flanges

[Unit : mm]

Size (NPS)	Class 150				Class 300				Class 400				Class 600			
	D1	D2	D3	D4	D1	D2	D3	D4	D1	D2	D3	D4	D1	D2	D3	D4
1/2	14.2	19.1	31.8	47.8	14.2	19.1	31.8	54.1	14.2	19.1	31.8	54.1	14.2	19.1	31.8	54.1
3/4	20.6	25.4	39.6	57.2	20.6	25.4	39.6	66.8	20.6	25.4	39.6	66.8	20.6	25.4	39.6	66.8
1	26.9	31.8	47.8	66.8	26.9	31.8	47.8	73.2	26.9	31.8	47.8	73.2	26.9	31.8	47.8	73.2
1-1/4	38.1	47.8	60.5	76.2	38.1	47.8	60.5	82.6	38.1	47.8	60.5	82.6	38.1	47.8	60.5	82.6
1-1/2	44.5	54.1	69.9	85.9	44.5	54.1	69.9	95.3	44.5	54.1	69.9	95.3	44.5	54.1	69.9	95.3
2	55.6	69.9	85.9	104.9	55.6	69.9	85.9	111.3	55.6	69.9	85.9	111.3	55.6	69.9	85.9	111.3
2-1/2	66.5	82.6	98.6	124.0	66.5	82.6	98.6	130.3	66.5	82.6	98.6	130.3	66.5	82.6	98.6	130.3
3	81.0	101.6	120.7	136.7	81.0	101.6	120.7	149.4	78.7	101.6	120.7	149.4	81.0	101.6	120.7	149.4
4	106.4	127.0	149.4	174.8	106.4	127.0	149.4	181.1	102.6	120.7	149.4	177.8	102.6	120.7	149.4	193.8
5	131.8	155.7	177.8	196.9	131.8	155.7	177.8	215.9	128.3	147.6	177.8	212.9	128.3	147.6	177.8	241.3
6	157.2	182.6	209.6	222.3	157.2	182.6	209.6	251.0	154.9	174.8	209.6	247.7	154.9	174.8	209.6	266.7
8	215.9	233.4	263.7	279.4	215.9	233.4	263.7	308.1	205.7	225.6	263.7	304.8	205.7	225.6	263.7	320.8
10	268.2	287.3	317.5	339.9	268.2	287.3	317.5	362.0	255.3	274.6	317.5	358.9	255.3	274.6	317.5	400.1
12	317.5	339.9	374.7	409.7	317.5	339.9	374.7	422.4	307.3	327.2	374.7	419.1	307.3	327.2	374.7	457.2
14	349.3	371.6	406.4	450.9	349.3	371.6	406.4	485.9	342.9	362.0	406.4	482.6	342.9	362.0	406.4	492.3
16	400.1	422.4	463.6	514.4	400.1	422.4	463.6	539.8	389.9	412.8	463.6	536.7	389.9	412.8	463.6	565.2
18	449.3	474.7	527.1	549.4	449.3	474.7	527.1	596.9	438.2	469.9	527.1	593.9	438.2	469.9	527.1	612.9
20	500.1	525.5	577.9	606.6	500.1	525.5	577.9	654.1	489.0	520.7	577.9	647.7	489.0	520.7	577.9	682.8
*22	552.4	577.8	635.0	660.4	552.4	577.8	635.0	704.8	552.4	577.8	635.0	701.8	552.4	577.8	635.0	733.6
24	603.3	628.7	685.8	717.6	603.3	628.7	685.8	774.7	590.6	628.7	685.8	768.4	590.6	628.7	685.8	790.7

22" : Facing Dimensions for JPI 7S-41-2005

### ASME B16.5 Pipes Flanges

[Unit : mm]

Size (NPS)	Class 900				Class 1500				Class 2500			
	D1	D2	D3	D4	D1	D2	D3	D4	D1	D2	D3	D4
1/2	14.2	19.1	31.8	63.5	14.2	19.1	31.8	63.5	14.2	19.1	31.8	69.9
3/4	20.6	25.4	39.6	69.9	20.6	25.4	39.6	69.9	20.6	25.4	39.6	76.2
1	26.9	31.8	47.8	79.5	26.9	31.8	47.8	79.5	26.9	31.8	47.8	85.9
1-1/4	33.3	39.6	60.5	88.9	33.3	39.6	60.5	88.9	33.3	39.6	60.5	104.9
1-1/2	41.4	47.8	69.9	98.6	41.4	47.8	69.9	98.6	41.4	47.8	69.9	117.6
2	52.3	58.7	85.9	143.0	52.3	58.7	85.9	143.0	52.3	58.7	85.9	146.1
2-1/2	63.5	69.9	98.6	165.1	63.5	69.9	98.6	165.1	63.5	69.9	98.6	168.4
3	78.7	95.3	120.7	168.4	78.7	92.2	120.7	174.8	78.7	92.2	120.7	196.9
4	102.6	120.7	149.4	206.5	97.8	117.6	149.4	209.6	97.8	117.6	149.4	235.0
5	128.3	147.6	177.8	247.7	124.5	143.0	177.8	254.0	124.5	143.0	177.8	279.4
6	154.9	174.8	209.6	289.1	147.3	171.5	209.6	282.7	147.3	171.5	209.6	317.5
8	196.9	222.3	257.3	358.9	196.9	215.9	257.3	352.6	196.9	215.9	257.3	387.4
10	246.1	276.4	311.2	435.1	246.1	266.7	311.2	435.1	246.1	270.0	311.2	476.3
12	292.1	323.9	368.3	498.6	292.1	323.9	368.3	520.7	292.1	317.5	368.3	549.4
14	320.8	355.6	400.1	520.7	320.8	362.0	400.1	577.9	-	-	-	-
16	374.7	412.8	457.2	574.8	368.3	406.4	457.2	641.4	-	-	-	-
18	425.5	463.6	520.7	638.3	425.5	463.6	520.7	704.9	-	-	-	-
20	482.6	520.7	571.5	698.5	476.3	514.4	571.5	755.7	-	-	-	-
24	590.6	628.7	679.5	838.2	577.9	616.0	679.5	901.7	-	-	-	-

22" : Facing Dimensions for JPI7S-41-1998

## Gasket Standard Dimension Table

### Spiral Wound Gaskets Dimension

#### ASME B16.20 (2007)

#### ASME B16.47 Series "A" Large Diameter Steel Flanges (MSS SP-44 Flanges)

[Unit : mm]

Size (NPS)	Class 150				Class 300				Class 400				Class 600				Class 900			
	D1	D2	D3	D4	D1	D2	D3	D4	D1	D2	D3	D4	D1	D2	D3	D4	D1	D2	D3	D4
26	654.1	673.1	704.9	774.7	654.1	685.8	736.6	835.2	660.4	685.8	736.6	831.9	647.7	685.8	736.6	866.9	660.4	685.8	736.6	882.7
28	704.9	723.9	755.7	831.9	704.9	736.6	787.4	898.7	711.2	736.6	787.4	892.3	698.5	736.6	787.4	914.4	711.2	736.6	787.4	946.2
30	755.7	774.7	806.5	882.7	755.7	793.8	844.6	952.5	755.7	793.8	844.6	946.2	755.7	793.8	844.6	971.6	768.4	793.8	844.6	1009.7
32	806.5	825.5	860.6	939.8	806.5	850.9	901.7	1006.6	812.8	850.9	901.7	1003.3	812.8	850.9	901.7	1022.4	812.8	850.9	901.7	1073.2
34	857.3	876.3	911.4	990.6	857.3	901.7	952.5	1057.4	863.6	901.7	952.5	1054.1	863.6	901.7	952.5	1073.2	863.6	901.7	952.5	1136.7
36	908.1	927.1	968.5	1047.8	908.1	955.8	1006.6	1117.6	917.7	955.8	1006.6	1117.6	917.7	955.8	1006.6	1130.3	920.8	958.9	1009.7	1200.2
38	958.9	977.9	1019.3	1111.3	952.5	977.9	1016.0	1054.1	952.5	971.6	1022.4	1073.2	952.5	990.6	1041.4	1104.9	1009.7	1035.1	1085.9	1200.2
40	1009.7	1028.7	1070.1	1162.1	1003.3	1022.4	1070.1	1114.6	1000.3	1025.7	1076.5	1127.3	1009.7	1047.8	1098.6	1155.7	1060.5	1098.6	1149.4	1251.0
42	1060.5	1079.5	1124.0	1219.2	1054.1	1073.2	1120.9	1165.4	1051.1	1076.5	1127.3	1178.1	1066.8	1104.9	1155.7	1219.2	1111.3	1149.4	1200.2	1301.8
44	1111.3	1130.3	1178.1	1276.4	1104.9	1130.3	1181.1	1219.2	1104.9	1130.3	1181.1	1231.9	1111.3	1162.1	1212.9	1270.0	1155.7	1206.5	1257.3	1368.6
46	1162.1	1181.1	1228.9	1327.2	1152.7	1178.1	1228.9	1273.3	1168.4	1193.8	1244.6	1289.1	1162.1	1212.9	1263.7	1327.2	1219.2	1270.0	1320.8	1435.1
48	1212.9	1231.9	1279.7	1384.3	1209.8	1235.2	1286.0	1324.1	1206.5	1244.6	1295.4	1346.2	1219.2	1270.0	1320.8	1390.7	1270.0	1320.8	1371.6	1485.9
50	1263.7	1282.7	1333.5	1435.1	1244.6	1295.4	1346.2	1378.0	1257.3	1295.4	1346.2	1403.4	1270.0	1320.8	1371.6	1447.8	-	-	-	-
52	1314.5	1333.5	1384.3	1492.3	1320.8	1346.2	1397.0	1428.8	1308.1	1346.2	1397.0	1454.2	1320.8	1371.6	1422.4	1498.6	-	-	-	-
54	1358.9	1384.3	1435.1	1549.4	1352.6	1403.4	1454.2	1492.3	1352.6	1403.4	1454.2	1517.7	1378.0	1428.8	1479.6	1555.8	-	-	-	-
56	1409.7	1435.1	1485.9	1606.6	1403.4	1454.2	1505.0	1543.1	1403.4	1454.2	1505.0	1568.5	1428.8	1479.6	1530.4	1612.9	-	-	-	-
58	1460.5	1485.9	1536.7	1663.7	1447.8	1511.3	1562.1	1593.9	1454.2	1505.0	1555.8	1619.3	1473.2	1536.7	1587.5	1663.7	-	-	-	-
60	1511.3	1536.7	1587.5	1714.5	1524.0	1562.1	1612.9	1644.7	1517.7	1568.5	1619.3	1682.8	1530.4	1593.9	1644.7	1733.6	-	-	-	-

#### ASME B 16.47 Series "B" Large Diameter Steel Flanges (API 605 Flanges)

[Unit : mm]

Size (NPS)	Class 150				Class 300				Class 400				Class 600				Class 900			
	D1	D2	D3	D4	D1	D2	D3	D4	D1	D2	D3	D4	D1	D2	D3	D4	D1	D2	D3	D4
26	654.1	673.1	698.5	725.4	654.1	673.1	711.2	771.7	654.1	666.8	698.5	746.3	644.7	663.7	714.5	765.3	666.8	692.2	749.3	838.2
28	704.9	723.9	749.3	776.2	704.9	723.9	762.0	825.5	701.8	714.5	749.3	800.1	685.8	704.9	755.7	819.2	717.6	743.0	800.1	901.7
30	755.7	774.7	800.1	827.0	755.7	774.7	812.8	886.0	752.6	765.3	806.5	857.3	752.6	778.0	828.8	879.6	781.1	806.5	857.3	958.9
32	806.5	825.5	850.9	881.1	806.5	825.5	863.6	939.8	800.1	812.8	860.6	911.4	793.8	831.9	882.7	933.5	838.2	863.6	914.4	1016.0
34	857.3	876.3	908.1	935.0	857.3	876.3	914.4	993.9	850.9	866.9	911.4	962.2	850.9	889.0	939.8	997.0	895.4	920.8	971.6	1073.2
36	908.1	927.1	958.9	987.6	908.1	927.1	965.2	1047.8	898.7	917.7	965.2	1022.4	901.7	939.8	990.6	1047.8	920.8	946.2	997.0	1124.0
38	958.9	974.6	1009.7	1044.7	971.6	1009.7	1047.8	1098.6	952.5	971.6	1022.4	1073.2	952.5	990.6	1041.4	1104.9	1009.7	1035.1	1085.9	1200.2
40	1009.7	1022.4	1063.8	1095.5	1022.4	1060.5	1098.6	1149.4	1000.3	1025.7	1076.5	1127.3	1009.7	1047.8	1098.6	1155.7	1060.5	1098.6	1149.4	1251.0
42	1060.5	1079.5	1114.6	1146.3	1085.9	1111.3	1149.4	1200.2	1051.1	1076.5	1127.3	1178.1	1066.8	1104.9	1155.7	1219.2	1111.3	1149.4	1200.2	1301.8
44	1111.3	1124.0	1165.4	1197.1	1124.0	1162.1	1200.2	1251.0	1104.9	1130.3	1181.1	1231.9	1111.3	1162.1	1212.9	1270.0	1155.7	1206.5	1257.3	1368.6
46	1162.1	1181.1	1224.0	1255.8	1178.1	1216.2	1254.3	1317.8	1168.4	1193.8	1244.6	1289.1	1162.1	1212.9	1263.7	1327.2	1219.2	1270.0	1320.8	1435.1
48	1212.9	1231.9	1270.0	1306.6	1231.9	1263.7	1311.4	1368.6	1206.5	1244.6	1295.4	1346.2	1219.2	1270.0	1320.8	1390.7	1270.0	1320.8	1371.6	1485.9
50	1263.7	1282.7	1325.6	1357.4	1267.0	1317.8	1355.9	1419.4	1257.3	1295.4	1346.2	1403.4	1270.0	1320.8	1371.6	1447.8	-	-	-	-
52	1314.5	1333.5	1376.4	1408.2	1317.8	1368.6	1406.7	1470.2	1308.1	1346.2	1397.0	1454.2	1320.8	1371.6	1422.4	1498.6	-	-	-	-
54	1365.3	1384.3	1422.4	1463.8	1365.3	1403.4	1454.2	1530.4	1352.6	1403.4	1454.2	1517.7	1378.0	1428.8	1479.6	1555.8	-	-	-	-
56	1422.4	1444.8	1478.0	1514.6	1428.8	1479.6	1524.0	1593.9	1403.4	1454.2	1505.0	1568.5	1428.8	1479.6	1530.4	1612.9	-	-	-	-
58	1478.0	1500.1	1528.8	1579.6	1484.4	1535.2	1573.3	1655.8	1454.2	1505.0	1555.8	1619.3	1473.2	1536.7	1587.5	1663.7	-	-	-	-
60	1535.2	1557.3	1586.0	1630.4	1557.3	1589.0	1630.4	1706.6	1517.7	1568.5	1619.3	1682.8	1530.4	1593.9	1644.7	1733.6	-	-	-	-

## Gasket Standard Dimension Table

### Spiral Wound Gaskets Dimension

KS B 1518 (2007), JIS B 2404 (2006)

Gasket Type : Inner & Outer Ring type

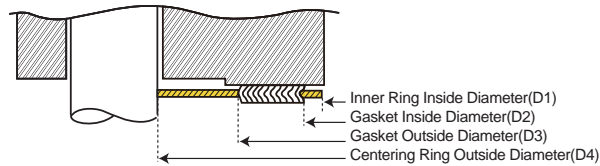

KS B 1503, KS B 1511, JIS B 2220, JIS B 2238, JIS B 2239, JIS B 2240

[Unit : mm]

Size (A)	10kgf/cm <sup>2</sup>				16kgf/cm <sup>2</sup>				20kgf/cm <sup>2</sup>			
	D1	D2	D3	D4	D1	D2	D3	D4	D1	D2	D3	D4
10	18	24	37	52	18	24	37	52	18	24	37	52
15	22	28	41	57	22	28	41	57	22	28	41	57
20	28	34	47	62	28	34	47	62	28	34	47	62
25	34	40	53	74	34	40	53	74	34	40	53	74
32	43	51	67	84	43	51	67	84	43	51	67	84
40	49	57	73	89	49	57	73	89	49	57	73	89
50	61	69	89	104	61	69	89	104	61	69	89	104
65	77	87	107	124	77	87	107	124	77	87	107	124
80	89	98	118	134	89	99	119	140	89	99	119	140
90	102	110	130	144	102	114	139	150	102	114	139	150
100	115	123	143	159	115	127	152	165	115	127	152	165
125	140	148	173	190	140	152	177	202	140	152	177	202
150	166	174	199	220	166	182	214	237	166	182	214	237
175	192	201	226	245	-	-	-	-	-	-	-	-
200	217	227	252	270	217	233	265	282	217	233	265	282
225	243	252	277	290	-	-	-	-	-	-	-	-
250	268	278	310	332	268	288	328	354	268	288	328	354
300	319	329	361	377	319	339	379	404	319	339	379	404
350	356	366	406	422	356	376	416	450	356	376	416	450
400	407	417	457	484	407	432	482	508	407	432	482	508
450	458	468	518	539	458	483	533	573	458	483	533	573
500	508	518	568	594	508	533	583	628	508	533	583	628
550	559	569	619	650	559	584	634	684	559	584	634	684
600	610	620	670	700	610	635	685	734	610	635	685	734
650	672	692	724	750	684	704	754	784	704	724	774	805
700	715	731	767	810	734	754	804	836	754	774	824	855
750	785	807	839	870	792	814	864	896	812	834	884	918
800	818	841	881	920	818	841	891	945	872	894	944	978
850	881	903	939	970	892	914	964	995	932	954	1004	1038
900	931	953	989	1020	942	964	1014	1045	982	1004	1054	1088
1000	1021	1058	1094	1124	1050	1074	1124	1158	-	-	-	-
1100	1144	1168	1204	1234	1150	1174	1224	1258	-	-	-	-
1200	1249	1273	1309	1344	1260	1284	1334	1368	-	-	-	-
1300	-	-	-	-	1354	1384	1434	1474	-	-	-	-
1350	1398	1428	1464	1498	1414	1444	1494	1534	-	-	-	-
1400	-	-	-	-	1464	1494	1544	1584	-	-	-	-
1500	1553	1583	1619	1658	1574	1604	1654	1684	-	-	-	-

22" : Facing Dimensions for JPI 7S-41-2005

Size (NPS)	20K			
	D1	D2	D3	D4
10	24	30	42	52
15	28	34	46	57
20	33	39	51	62
25	44	50	63	74
32	52	59	73	84
40	56	63	78	89
50	69	77	93	104
65	80	92	112	124

**Remark**

1. Class 10K with Inner & Outer Ring type Gasket dimension designed by JEIL.
2. Over 650A Gasket Dimension designed by JEIL.
3. Facing dimension for KS B 1503 and JIS B 2220 flange 20K facing flange should be Slip On Type. B type(NPS 10~65A) should be apply left dimension table.



## Gasket Standard Dimension Table

### Spiral Wound Gaskets Dimension

KS B1518 (2007), JIS B2404 (2006)

Gasket Type : Inner & Outer Ring type

KS B 1503, KS B 1511, JIS B 2220, JIS B 2238, JIS B 2239, JIS B 2240

[Unit : mm]

Size (NPS)	30kgf/cm <sup>2</sup>				40kgf/cm <sup>2</sup>				63kgf/cm <sup>2</sup>			
	D1	D2	D3	D4	D1	D2	D3	D4	D1	D2	D3	D4
10	18	24	37	59	15	21	34	59	15	21	34	64
15	22	28	41	64	18	24	37	64	18	24	37	69
20	28	34	47	69	23	29	42	69	23	29	42	75
25	34	40	53	79	29	35	48	79	29	35	48	80
32	43	51	67	89	38	44	60	89	38	44	60	90
40	49	57	73	100	43	51	67	100	43	51	67	107
50	61	69	89	114	55	63	79	114	55	63	79	125
65	68	78	98	140	68	78	98	140	68	78	98	152
80	80	90	110	150	80	90	110	150	80	90	110	162
90	92	102	127	162	92	102	127	162	92	102	127	179
100	104	116	141	172	104	116	141	182	104	116	141	194
125	128	140	165	207	128	140	165	224	128	140	165	235
150	153	165	197	249	153	165	197	265	153	165	197	275
175	-	-	-	-	-	-	-	-	-	-	-	-
200	202	218	250	294	202	218	250	315	202	218	250	328
225	-	-	-	-	-	-	-	-	-	-	-	-
250	251	271	311	360	251	271	311	378	251	271	311	394
300	300	320	360	418	300	320	360	434	300	320	360	446
350	336	356	396	463	336	356	396	479	336	356	396	488
400	383	403	453	524	383	403	453	531	383	403	453	545

22" : Facing Dimensions for JPI 7S-41-2005

Size (NPS)	30k			
	D1	D2	D3	D4
10	30	36	46	59
15	35	41	51	64
20	39	45	56	69
25	48	54	66	79
32	56	62	75	89
40	63	69	84	100
50	77	83	99	114
65	90	100	120	140

#### Remark

1. NPS below 30K 50A applied by Raised Face Type Flange only
2. Dimension over 30K 65A and 40K, 63K facing gasket should be applied at KS B 1503 and JIS B 2220 Welding Neck Type or C type (socket welding flange)
3. Facing dimension for KS B 1503 and JIS B 2220 class over 30K applied to slip on type or B type (NPS 10-65A) will be follow as left table.

# Gasket Standard Dimension Table

## Ring Joint Gaskets Dimension

ASME B 16.20 (2007)

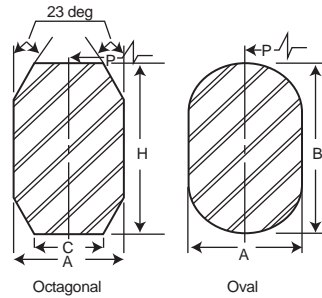

[Unit : mm]

Ring No.	Flanges (Pressure Classes)												Gasket Dimension						
	ASME B 16.5 (JPI - 7S - 15)				API 6B					ASME B 16.47 SERIES A			P ±0.18	A ±0.20	T +1.3~0.5		C ±0.20	R <sub>1</sub> ±0.50	
	150	300~600	900	1500	2500	700~960	2000	3000	5000	10000	150	300~600			900	Oval B			Octagonal H
R11		1/2												34.14	6.35	11.2	9.7	4.32	1.5
R12			1/2	1/2										39.70	7.95	14.2	12.7	5.23	1.5
R13		3/4			1/2									42.88	7.95	14.2	12.7	5.23	1.5
R14			3/4	3/4										44.45	7.95	14.2	12.7	5.23	1.5
R15	1													47.63	7.95	14.2	12.7	5.23	1.5
R16		1	1	1	3/4	1	1	1	1					50.80	7.95	14.2	12.7	5.23	1.5
R17	1-1/4													57.15	7.95	14.2	12.7	5.23	1.5
R18		1-1/4	1-1/4	1-1/4	1	1-1/4	1-1/4	1-1/4	1-1/4					60.33	7.95	14.2	12.7	5.23	1.5
R19	1-1/2													65.10	7.95	14.2	12.7	5.23	1.5
R20		1-1/2	1-1/2	1-1/2		1-1/2	1-1/2	1-1/2	1-1/2					68.28	7.95	14.2	12.7	5.23	1.5
R21					1-1/4									72.24	11.13	17.5	16.0	7.75	1.5
R22	2													82.55	7.95	14.2	12.7	5.23	1.5
R23		2			1-1/2	2	2							82.55	11.13	17.5	16.0	7.75	1.5
R24			2	2				2	2					95.25	11.13	17.5	16.0	7.75	1.5
R25	2-1/2													101.60	7.95	14.2	12.7	5.23	1.5
R26		2-1/2			2	2-1/2	2-1/2							101.60	11.13	17.5	16.0	7.75	1.5
R27			2-1/2	2-1/2				2-1/2	2-1/2					107.95	11.13	17.5	16.0	7.75	1.5
R28					2-1/2									111.13	12.70	19.1	17.5	8.66	1.5
R29	3													114.30	7.95	14.2	12.7	5.23	1.5
# R30		3												117.48	11.13	17.5	16.0	7.75	1.5
R31		3	3			3	3	3						123.83	11.13	17.5	16.0	7.75	1.5
R32					3									127.00	12.70	19.1	17.5	8.66	1.5
R33	3-1/2													131.78	7.95	14.2	12.7	5.23	1.5
R34		3-1/2												131.78	11.13	17.5	16.0	7.75	1.5
R35				3					3					136.53	11.13	17.5	16.0	7.75	1.5
R36	4													149.23	7.95	14.2	12.7	5.23	1.5
R37		4	4			4	4	4	3-1/2					149.23	11.13	17.5	16.0	7.75	1.5
R38					4									157.18	15.88	22.4	20.6	10.49	1.5
R39				4					4					161.93	11.13	17.5	16.0	7.75	1.5
R40	5													171.45	7.95	14.2	12.7	5.23	1.5
R41		5	5			5	5	5						180.98	11.13	17.5	16.0	7.75	1.5
R42					5									190.50	19.05	25.4	23.9	12.32	1.5
R43	6													193.68	7.95	14.2	12.7	5.23	1.5
R44				5					5					193.68	11.13	17.5	16.0	7.75	1.5
R45		6	6			6	6	6						211.15	11.13	17.5	16.0	7.75	1.5
R46				6					6					211.15	12.70	19.1	17.5	8.66	1.5
R47					6									228.60	19.05	25.4	23.9	12.32	1.5
R48	8													247.65	7.95	14.2	12.7	5.23	1.5
R49		8	8			8	8	8						269.88	11.13	17.5	16.0	7.75	1.5
R50				8					8					269.88	15.88	22.4	20.6	10.49	1.5
R51					8									279.40	22.23	28.7	26.9	14.81	1.5
R52	10													304.80	7.95	14.2	12.7	5.23	1.5
R53		10	10			10	10	10						323.85	11.13	17.5	16.0	7.75	1.5
R54				10					10					323.85	15.88	22.4	20.6	10.49	1.5
R55					10									342.90	28.58	36.6	35.1	19.81	2.3

## Gasket Standard Dimension Table

## Ring Joint Gaskets Dimension

[Unit : mm]

Ring No.	Flanges (Pressure Classes)												Gasket Dimension						
	ASME B 16.5 (JPI - 7S - 15)					API 6B					ASME B 16.47 SERIES A			P ±0.18	A ±0.20	T +1.3-0.5		C ±0.20	R <sub>1</sub> ±0.50
	150	300~600	900	1500	2500	700~960	2000	3000	5000	10000	150	300~600	900			Oval B	Octagonal H		
R56	12													381.00	7.95	14.2	12.7	5.23	1.5
R57		12	12			12	12	12						381.00	11.13	17.5	16.0	7.75	1.5
R58				12										381.00	22.23	28.7	26.9	14.81	1.5
R59	14													396.88	7.95	14.2	12.7	5.23	1.5
R60					12									406.40	31.75	39.6	38.1	22.33	2.3
R61		14				14	14	14						419.10	11.13	17.5	16.0	7.75	1.5
R62			14											419.10	15.88	22.4	20.6	10.49	1.5
R63				14										419.10	25.40	33.3	31.8	17.30	2.3
R64	16													454.03	7.95	14.2	12.7	5.23	1.5
R65		16				16	16							469.90	11.13	17.5	16.0	7.75	1.5
R66			16					16						469.90	15.88	22.4	20.6	10.49	1.5
R67				16										469.90	28.58	36.6	35.1	19.81	2.3
R68	18													517.53	7.95	14.2	12.7	5.23	1.5
R69		18				18	18							533.40	11.13	17.5	16.0	7.75	1.5
R70			18					18						533.40	19.05	25.4	23.9	12.32	1.5
R71				18										533.40	28.58	36.6	35.1	19.81	2.3
R72	20													558.80	7.95	14.2	12.7	5.23	1.5
R73		20				20	20							584.20	12.70	19.1	17.5	8.66	1.5
R74			20					20						584.20	19.05	25.4	23.9	12.32	1.5
R75				20										584.20	31.75	39.6	38.1	22.33	2.3
R76	24													673.10	7.95	14.2	12.7	5.23	1.5
R77		24												692.15	15.88	22.4	20.6	10.49	1.5
R78			24											692.15	25.40	33.3	31.8	17.30	2.3
R79				24										692.15	34.93	44.5	41.4	24.82	2.3
R80														615.95	7.95	-	12.7	5.23	1.5
R81														635.00	14.30	-	19.1	9.58	1.5
R82									1					57.15	11.13	-	16.0	7.75	1.5
R84									1-1/2					63.50	11.13	-	16.0	7.75	1.5
R85									2					79.38	12.70	-	17.5	8.66	1.5
R86									2-1/2					90.50	15.88	-	20.6	10.49	1.5
R87									3					100.03	15.88	-	20.6	10.49	1.5
R88									4					123.83	19.05	-	23.9	12.32	1.5
R89									3-1/2					114.30	19.05	-	23.9	12.32	1.5
R90									5					155.58	22.23	-	26.9	14.81	1.5
R91									10					260.35	31.75	-	38.1	22.33	2.3
R92														228.60	11.13	17.5	16.0	7.75	1.5
R93		* 26										26		749.30	19.05	-	23.9	12.32	1.5
R94		* 28										28		800.10	19.05	-	23.9	12.32	1.5
R95		* 30										30		857.25	19.05	-	23.9	12.32	1.5
R96		* 32										32		914.40	22.23	-	26.9	14.81	1.5
R97		* 34										34		965.20	22.23	-	26.9	14.81	1.5
R98		* 36										36		1022.35	22.23	-	26.9	14.81	1.5
R99							8	8						234.95	11.13	-	16.0	7.75	1.5
R100			* 26									26		749.30	28.58	-	35.1	19.81	2.3
R101			* 28									28		800.10	31.75	-	38.1	22.33	2.3
R102			* 30									30		857.25	31.75	-	38.1	22.33	2.3
R103			* 32									32		914.40	31.75	-	38.1	22.33	2.3
R104			* 34									34		965.20	34.93	-	41.4	24.82	2.3
R105			* 36									36		1022.35	34.93	-	41.4	24.82	2.3

1) Table are based on the use of gasket with ring type flange of JPI-7S-23, ASME B16.20. API SPEC 6A.

2) #R30 only be supplied on the class 400 &amp; 600 PSI and lapped joint.

3) \* Applied of JPI-7S-23 only.

## Gasket Standard Dimension Table

### Kammprofile Gaskets Dimension

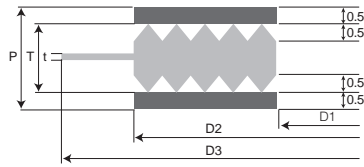

### ASME B16.5 Flange / EN 12560 - 6

[Unit : mm]

Size (NPS)	D <sub>1</sub>	D <sub>2</sub>	D <sub>3</sub>						
			Class150	Class300	Class400	Class600	Class900	Class1500	Class2500
1/2	23.0	33.3	44.4	50.8	50.8	50.8	60.3	60.3	66.7
3/4	28.6	39.7	53.9	63.5	63.5	63.5	66.7	66.7	73.0
1	36.5	47.6	63.5	69.8	63.5	69.5	76.2	76.2	82.5
1-1/4	44.4	60.3	73.0	79.4	79.4	79.4	85.7	85.7	101.6
1-1/2	52.4	69.8	82.5	92.1	92.1	92.1	95.2	95.2	114.3
2	69.8	88.9	101.8	108.0	108.0	108.0	139.7	139.7	142.8
2-1/2	82.5	101.6	120.6	127.0	127.0	127.0	161.9	161.9	165.1
3	98.4	123.8	133.4	146.1	146.1	146.1	165.1	171.5	193.7
3-1/2	111.1	136.5	158.8	161.9	158.7	158.7	-	-	-
4	123.8	154.0	171.5	177.8	174.6	190.5	203.2	206.4	231.7
5	150.8	182.6	193.7	212.7	209.5	238.1	244.5	250.8	276.2
6	177.8	212.7	219.1	247.7	244.5	263.5	285.8	279.4	314.3
8	228.6	266.7	276.2	304.8	301.6	317.5	355.6	349.3	384.1
10	282.6	320.7	336.5	358.8	355.6	396.9	431.8	431.8	473.0
12	339.7	377.8	406.4	419.1	415.9	454.0	495.3	517.5	546.1
14	371.5	409.6	447.7	482.6	479.4	488.9	517.5	574.7	-
16	422.3	466.7	511.2	536.6	533.4	561.9	571.5	638.1	-
18	479.4	530.2	546.1	593.7	590.5	609.6	635.0	701.7	-
20	530.2	581.0	603.2	650.9	644.5	679.5	695.3	752.4	-
24	631.8	682.6	714.4	771.5	765.2	787.4	835.0	898.5	-

### ASME B16.47 Series A Flange

[Unit : mm]

Size (NPS)	D <sub>1</sub>	D <sub>2</sub>	D <sub>3</sub>				
			Class150	Class300	Class400	Class600	Class900
26	690	740	772	832	829	864	880
28	740	790	829	895	889	911	943
30	800	850	880	949	943	968	1007
32	845	905	937	1003	1000	1019	1070
34	895	955	987	1054	1051	1070	1134
36	950	1010	1045	1114	1114	1127	1197
38	960	1020	1108	1051	1070	1102	1197
40	1015	1075	1159	1111	1124	1153	1248
42	1065	1125	1216	1162	1175	1216	1299
44	1125	1185	1273	1216	1229	1267	1365
46	1175	1235	1324	1270	1286	1324	1432
48	1220	1290	1381	1321	1343	1388	1483
50	1270	1350	1432	1376	1400	1445	-
52	1320	1400	1489	1426	1451	1495	-
54	1375	1455	1546	1489	1515	1553	-
56	1430	1510	1603	1540	1565	1610	-
58	1485	1565	1661	1591	1616	1661	-
60	1535	1615	1711	1642	1680	1730	-



## Gasket Chemical Resistance Chart

Medium	Molecular Formula	JIC 6000	JIC 6010	JIC 6100	JIC 6200	JIC 6400	JIC 8310	JIC 4201
Acetic acid	CH <sub>3</sub> COOH	A	A	B	A	B	A	A
Acetic acid, glacial		A	A	A	A	B	A	A
Acetone	CH <sub>3</sub> COCH <sub>3</sub>	B	B	A	B	C	A	A
Acetic anhydride	(CH <sub>3</sub> CO) <sub>2</sub> O	A	A	A	A	A	A	A
Acetylene	C <sub>2</sub> H <sub>2</sub>	A	A	B	A	A	A	A
Acrylonitrile						C		
Alum	KAl(SO <sub>4</sub> ) <sub>2</sub>	A	A	A	A	A	A	A
Ammonia	NH <sub>3</sub>	A	A	A	A	A	A	A
Ammonia anhydrous		A	A	A	A	A	A	A
Ammonium hydroxide	NH <sub>4</sub> OH	A	A		A	A	A	A
Aniline	C <sub>6</sub> H <sub>5</sub> NH <sub>2</sub>	C	C	B	C	C	A	A
Asphalt (TAR)		B	B	B	B	A	A	A
ASTM oil NO 1		A	A	B	A	A	A	A
ASTM oil NO 3		A	A	B	A	A	A	A
Barium chloride	BaCl <sub>2</sub>	A	A	A	A	A	A	A
Benzene	C <sub>6</sub> H <sub>6</sub>	B	B	C	B	C	A	A
Benzoic acid		B	B	B	B	B	A	A
Boiler feed water		A	A	A	A	A	A	A
Borax	Na <sub>2</sub> B <sub>4</sub> O <sub>7</sub> ·10H <sub>2</sub> O	A	A		A	A	A	A
Butane	C <sub>4</sub> H <sub>10</sub>	A	A	B	A	A	A	A
Butyl acetate	CH <sub>3</sub> COOC <sub>4</sub> H <sub>9</sub>	B	B	B	B	C	A	A
Butyl alcohol (Butanol)		A	A	A	A	A	A	A
Butyric acid		A	A	A	A	A	A	A
Calcium chloride	CaCl <sub>2</sub>	A	A	A	A	A	A	A
Calcium hydroxide	Ca(OH) <sub>2</sub>	A	A	A	A	A	A	A
Calcium sulphate	CaSO <sub>4</sub>	A	A		A	A	A	A
Carbon tetrachloride	CCl <sub>4</sub>	B	B	C	B	C	A	A
Carbonic acid 100%(Phenol)	C <sub>6</sub> H <sub>5</sub> OH	C	C	C	C	C	A	A
Carbon dioxide		A	A	A	A	A	A	A
Carbon disulfide	CS <sub>2</sub>	C	C	C	C	C	A	A
Caustic soda	NaOH	C	C	C	C	C	A	A
Chlorine (DRY)	Cl <sub>2</sub>	B	B	B	B	B	A	B
Chlorine (WET)	Cl <sub>2</sub>	C	C	C	C	C	A	B
Chromic acid	H <sub>2</sub> CrO <sub>4</sub>	B	B	C	B	C	A	C
Corn oil		A	A	B	A	A	A	A
Chloroform	CHCl <sub>3</sub>	B	B	C	B	C	A	A
Copper sulphate	CuSO <sub>4</sub>	A	A	A	A	A	A	A
Cresol	C <sub>6</sub> H <sub>4</sub> (OH)CH <sub>3</sub>	B	B		B	C	A	A
Crude oil		A	A	B	A	A	A	A
Creosote		C	C	C	C	B	A	A
Cyclo hexane	C <sub>6</sub> H <sub>12</sub>	A	A	B	A	A	A	A
Copper acetate	(CH <sub>3</sub> COO) <sub>2</sub> Cu	A	A		A	A	A	A
Detergent solutions		A	A	A	A	A	A	A
Di-benzyl ether	(C <sub>6</sub> H <sub>5</sub> CH <sub>2</sub> ) <sub>2</sub> O	C	C	C	C	C	A	A
Diesel oil		A	A	B	A	A	A	A
Dimethyl formamide	HCON(CH <sub>3</sub> ) <sub>2</sub>	C	C	C	C	C	A	A
Dioxane		C	C	C	C	C	A	

## Gasket Chemical Resistance Chart

Medium	Molecular Formula	JIC 6000	JIC 6010	JIC 6100	JIC 6200	JIC 6400	JIC 8310	JIC 4201
Ethane	C <sub>2</sub> H <sub>6</sub>	A	A	A	A	A	A	A
Ethyl alcohol(Ethanol)	C <sub>2</sub> H <sub>5</sub> OH	A	A	A	A	A	A	A
Ethyl acetate	CH <sub>3</sub> COOC <sub>2</sub> H <sub>5</sub>	B	B	B	B	C	A	A
Ethyl chloride	C <sub>2</sub> H <sub>5</sub> Cl	B	B	C	B	C	A	A
Ethyl ether	C <sub>2</sub> H <sub>5</sub> OC <sub>2</sub> H <sub>5</sub>	A	A	B	A	B	A	A
Ethylene chloride	(CH <sub>2</sub> Cl) <sub>2</sub>	C	C	C	C	C	A	A
Ethylene glycol	(CH <sub>2</sub> OH) <sub>2</sub>	A	A	A	A	A	A	A
Ferric chloride		A	A	A	A	A	A	A
Formaldehyde	HCHO	A	A	A	A	A	A	A
Formic acid 85%	HCOOH	C	C		C	C	A	A
Freon 11	CCl <sub>3</sub> F	B	B	C	B	B	A	A
Freon 12	CCl <sub>2</sub> F <sub>2</sub>	A	A	B	A	A	A	A
Fuel A		A	A	B	A	A	A	A
Fuel B		A	A	B	A	A	A	A
Fuel C		A	A	B	A	A	A	A
Gasoline		A	A	C	A	A	A	A
Glycerine	(CH <sub>2</sub> OH) <sub>2</sub> CHOH	A	A	A	A	A	A	A
Green sulfate liquor		B	B	B	B	C	A	A
Heptane	C <sub>7</sub> H <sub>16</sub>	A	A	C	A	A	A	A
Hydrochloric acid	HCl					C		
Hydrochloric acid 20%	HCl	B	B	C	B		A	A
Hydrochloric acid 37%	HCl	C	C	C	C		A	A
Hydrogen peroxide 3%	H <sub>2</sub> O <sub>2</sub>	B	B	A	B	B	A	A
Hydrogen peroxide 35%	H <sub>2</sub> O <sub>2</sub>	C	C	C	C	C	A	A
Isoamyl acetate	CH <sub>3</sub> COOCH <sub>2</sub> CH(CH <sub>3</sub> ) <sub>2</sub>	C	C	B	C	C	A	A
Isooctane		A	A	B	A	A	A	A
Isopropyl alcohol	(CH <sub>3</sub> ) <sub>2</sub> CHOH	A	A		A	A	A	A
Lactic acid 50%	CH <sub>3</sub> CHOHCOOH	A	A	A	A	A	A	A
Lime water	Ca(OH) <sub>2</sub>	A	A		A	B	A	A
Lin seed oil		A	A	B	A	A	A	A
Lubricating oil		A	A	B	A	A	A	A
Magnesium sulphate	MgSO <sub>4</sub>	A	A		A	A	A	A
Methyl acetate	CH <sub>3</sub> COOCH <sub>3</sub>					C		
Methyl acetate 97%	CH <sub>3</sub> COOCH <sub>3</sub>	C	C		C		A	A
Methyl acetate 60%	CH <sub>3</sub> COOCH <sub>3</sub>	C	C		C		A	A
Methyl alcohol(Methanol)	CH <sub>3</sub> OH	A	A	A	A	A	A	A
Mineral oil(ASTM No 1, 3)		A	A	B	A	A	A	A
Muriatic acid		C	C	C	C	C	A	A
Naphtha		B	B	B	B	A	A	A
Nitric acid 20%	HNO <sub>3</sub>	C	C	C	C	C	A	B
Nitric acid 40%	HNO <sub>3</sub>	C	C	C	C	C	A	B
Nitric acid 96%	HNO <sub>3</sub>	C	C	C	C	C	A	C
Nitrobenzene	C <sub>6</sub> H <sub>5</sub> NO <sub>2</sub>	C	C	C	C	C	A	A
Octane	C <sub>8</sub> H <sub>18</sub>	A	A	C	A	A	A	A
Oleic acid	C <sub>17</sub> H <sub>33</sub> COOH	A	A		A	B	A	A
Oleum		C	C	C	C	C	A	C

## Gasket Chemical Resistance Chart

Medium	Molecular Formula	JIC 6000	JIC 6010	JIC 6100	JIC 6200	JIC 6400	JIC 8310	JIC 4201
Pentane(C <sub>5</sub> H <sub>12</sub> )	C <sub>5</sub> H <sub>12</sub>	A	A		A	A	A	A
Palmitic acid	C <sub>15</sub> H <sub>31</sub> COOH	A	A		A	A	A	A
Perchloroethylene	C <sub>2</sub> Cl <sub>4</sub>	B	B	C	B	C	A	A
Petroleum ether		A	A	B	A	A	A	A
Phenol	C <sub>6</sub> H <sub>5</sub> OH	C	C	C	C	C	A	A
Phosphoric acid	H <sub>3</sub> PO <sub>4</sub>	A	A	B	A	C	A	A
Potassium carbonate	K <sub>2</sub> CO <sub>3</sub>	A	A		A	A	A	A
Potassium chloride	KCl	A	A		A	A	A	A
Potassium chlorate	KClO <sub>3</sub>	A	A		A	A	A	B
Potassium hydroxide	KOH	B	B	C	B	C	A	A
Potassium iodide	KI	A	A		A	B	A	A
Potassium nitrate	KNO <sub>3</sub>	A	A	A	A	B	A	A
Propane	C <sub>3</sub> H <sub>8</sub>	A	A	B	A	A	A	A
Propylene glycol	CH <sub>3</sub> CH(OH)CH <sub>2</sub> OH	A	A		A	C	A	A
Pyridine	C <sub>5</sub> H <sub>5</sub> N	C	C	B	C	C	A	A
Sea water		A	A	A	A	A	A	A
Soap		A	A	A	A	A	A	A
Sodium carbonate(Soda)	Na <sub>2</sub> CO <sub>3</sub>	A	A		A	A	A	A
Sodium aluminate	Na <sub>3</sub> AlO <sub>3</sub>	A	A		A	A	A	A
Sodium bisulphite	NaHSO <sub>3</sub>	A	A		A	A	A	A
Sodium hydroxide	NaOH	C	C	C	C	C	A	A
Sodium silicate (Water glass)		A	A	A	A	B	A	A
Sodium sulphate	Na <sub>2</sub> SO <sub>4</sub>	A	A	A	A	A	A	A
Sodium sulphide	Na <sub>2</sub> S	A	A		A	A	A	A
Starch	(C <sub>6</sub> H <sub>10</sub> O <sub>5</sub> ) <sub>x</sub>	A	A		A	A	A	A
Steam	H <sub>2</sub> O	C	C		C	B	A	A
Styrene								
Sulphur dioxide	SO <sub>2</sub>	C	C	B	C	C	A	A
Sulphuric acid 50%	H <sub>2</sub> SO <sub>4</sub>	C	C	C	C	C	A	B
Sulphurous acid	H <sub>2</sub> SO <sub>3</sub>	B	B		B	B	A	A
Tannic acid	C <sub>76</sub> H <sub>52</sub> O <sub>46</sub>	A	A	A	A	A	A	A
Tar(Asphalt)		B	B	B	B	A	A	A
Tartaric acid		A	A		A	A	A	A
Tetrachloroethane	C <sub>2</sub> H <sub>2</sub> Cl <sub>4</sub>	C	C	C	C	C	A	A
Toluene	C <sub>6</sub> H <sub>5</sub> CH <sub>3</sub>	B	B	C	B	C	A	A
Transformer oil		A	A	B	A	A	A	A
Vinyl acetate	CH <sub>3</sub> COOC <sub>2</sub> H <sub>3</sub>	A	A	C	A	B	A	A
Water	H <sub>2</sub> O	A	A	A	A	A	A	A
Xylene	C <sub>6</sub> H <sub>4</sub> (CH <sub>3</sub> ) <sub>2</sub>	B	B	C	B	C	A	A

The symbols used follows:









A : Suitable for application

B : Suitability depends on operating conditions

C : Not suitable



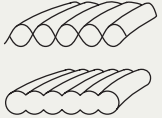

## Gasket Materials and Contact Facings

### ASME

Gasket Material	Gasket Factor m	Min. Design Seating Stress y psi(MPa)	Sketches	Facing Sketch and Column (see page 39)
Self-energizing types(o-rings, metallic, elastomer, other gasket types considered as self-sealing)	0	0(0)		
Elastomers without fabric or high percent of mineral fiber Below 75A Shore Durometer 75A or higher shore Durometer	0.50 1.00	0(0) 200(1.4)		(1a), (1b), (1c), (1d), (4), (5); Column II
mineral fiber with suitable binder for operating conditions: 1/8 in. (3.2mm) thick 1/16 in. (1.6mm) thick 1/8 in. (0.8mm) thick	2.00 2.75 3.50	1,600(11) 3,700(26) 6,500(45)		(1a), (1b), (1c), (1d), (4), (5); Column II
Elastomers with cotton fabric insertion	1.25	400(2.8)		(1a), (1b), (1c), (1d), (4), (5); Column II
Elastomers with mineral fiber fabric insertion(with or without wire reinforcement):				
3-ply	2.25	2,200(15)		(1a), (1b), (1c), (1d), (4), (5); Column II
2-ply	2.50	2,900(20)		
1-ply	2.75	3,700(26)		
Vegetable fiber	1.75	1,100(7.6)		(1a), (1b), (1c), (1d), (4), (5); Column II
Spiral-wound metal, mineral fiber Filled:				
Carbon	2.50	10,000(69)		(1a), (1b); Column II
Stainless, Monel, and nickel-base alloys	3.00	10,000(69)		
Corrugated metal, mineral fiber inserted, or corrugated metal, jacketed mineral fiber Filled:				
Soft aluminum	2.50	2,900(20)		(1a), (1b); Column II
Soft copper or brass	2.75	3,700(26)		
Iron or soft steel	3.00	4,500(31)		
Molel or 4%~6% chrome	3.25	5,500(38)		
Stainless steels and nickel-base alloys	3.50	6,500(45)		

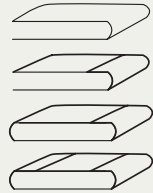

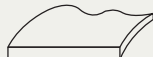
## Gasket Materials and Contact Facings

Gasket Material	Gasket Factor $m$	Min. Design Seating Stress $y$ Psi(MPA)	Sketchs	Facing Sketch and Column (see page 39)
Corrugated metal: Soft aluminum Soft copper or brass Iron or soft steel Molel or 4%~6% chrome Stainless steels and nickel-base alloys	2.75 3.00 3.25 3.50 3.75	3,700(26) 4,500(31) 5,500(38) 6,500(45) 7,600(52)		(1a), (1b), (1c), (1d); Column II
Flat metal, Jacketed mineral fiber filled: Soft aluminum Soft copper or brass Iron or soft steel Molel 4%~6% chrome Stainless steels and nickel-base alloys	3.25 3.50 3.75 3.50 3.75 3.75	5,500(38) 6,500(45) 7,600(52) 8,000(55) 9,000(62) 9,000(62)		(1a), (1b), (1c) <sup>2</sup> , (1d) <sup>2</sup> , (2) <sup>2</sup> ; Column II
Grooved metal: Soft aluminum Soft copper or brass Iron or soft metal Molel or 4%~6% chrome Stainless steels and nickel-base alloys	3.25 3.50 3.75 3.75 4.25	5,500(38) 6,500(45) 7,600(52) 9,000(62) 10,100(70)		(1a), (1b), (1c), (1d), (2), (3); Column II
Solid flat metal: Soft aluminum Soft copper or brass Iron or soft steel Molel or 4%~6% chrome Stainless steels and nickel-base alloys	4.00 4.75 5.50 6.00 6.50	8,800(61) 13,000(90) 18,000(124) 21,800(150) 26,000(180)		(1a), (1b), (1c), (1d), (2), (3), (4), (5); Column I
Ring joint: Iron or soft steel Molel or 4%~6% chrome Stainless steels and nickel-base alloys	5.50 6.00 6.50	18,000(124) 21,800(150) 26,000(180)		(6); Column I



*Technology for a better human life  
Seeking to Harmonize Industry and the Environment*



[www.jeilens.co.kr](http://www.jeilens.co.kr)

**HEAD OFFICE & FACTORY** 39-5, Yusan-Dong, Yangsan-City, Kyungnam, Korea Tel.055-383-1301 Fax.055-383-0853

**HWASEONG OFFICE & FACTORY** ( 3B #L Mado IND. Complex )

667-6, Ssangsong-Ri, Mado-Myun, Hwaseong-City, Kyunggi-Do, Korea Tel.031-357-6751~3 Fax.031-357-6754

**SEOUL OFFICE** 186, Bangyee-Dong, Songpa-Gu, Seoul, Korea Tel. 02-413-6090~2 Fax.02-413-6493

**YEOSOO OFFICE** 92-7, Shingi-Dong, Yeosoo-City, Cheonnam, Korea Tel.061-685-1150 Fax.061-685-1151

**QINGDAO JEIL E&S CO.,LTD.** Haibin Factory Complex, Jiaonan-City, Qingdao, China. Tel.86-532-8513 6021 Fax.86-532-8513 6020

**E-mail** [jeil@jeilens.co.kr](mailto:jeil@jeilens.co.kr)

**JES** 제일E&S주식회사  
JEIL E&S CO.,LTD